

**Agilent
FieldFox
RF Vector Network
Analyzer**

N9923A

User's Guide

Manufacturing Part Number: N9923-90001

Print Date: November 10, 2011

Supersedes: September 13, 2011

©Agilent Technologies, Inc. 2011



Agilent Technologies

Warranty Statement

The material contained in this document is provided "as is," and is subject to being changed, without notice, in future editions. Further, to the maximum extent permitted by applicable law, Agilent disclaims all warranties, either express or implied with regard to this manual and any information contained herein, including but not limited to the implied warranties of merchantability and fitness for a particular purpose. Agilent shall not be liable for errors or for incidental or consequential damages in connection with the furnishing, use, or performance of this document or any information contained herein. Should Agilent and the user have a separate written agreement with warranty terms covering the material in this document that conflict with these terms, the warranty terms in the separate agreement will control.

DFARS/Restricted Rights Notice

If software is for use in the performance of a U.S. Government prime contract or subcontract, Software is delivered and licensed as "Commercial computer software" as defined in DFAR 252.227-7014 (June 1995), or as a "commercial item" as defined in FAR 2.101(a) or as "Restricted computer software" as defined in FAR 52.227-19 (June 1987) or any equivalent agency regulation or contract clause. Use, duplication or disclosure of Software is subject to Agilent Technologies' standard commercial license terms, and non-DOD Departments and Agencies of the U.S. Government will receive no greater than Restricted Rights as defined in FAR 52.227-19(c)(1-2) (June 1987). U.S. Government users will receive no greater than Limited Rights as defined in FAR 52.227-14 (June 1987) or DFAR 252.227-7015 (b) (2) (November 1995), as applicable in any technical data.

Technology Licenses

The hardware and/or software described in this document are furnished under a license and may be used or copied only in accordance with the terms of such license.

Contacting Agilent

Assistance with test and measurements needs and information on finding a local Agilent office are available on the Web at: <http://www.agilent.com/find/assist>

If you do not have access to the Internet, please contact your Agilent field engineer.

In any correspondence or telephone conversation, refer to the Agilent product by its model number and full serial number. With this information, the Agilent representative can determine whether your product is still within its warranty period.

Safety and Regulatory Information

The safety and regulatory information pertaining to this product is located on page 107.

Where to Find the Latest Information

Documentation is updated periodically. For the latest information please visit:

<http://www.agilent.com/find/fieldfox>

Software Updates

Is your product software up-to-date? Periodically, Agilent releases software updates to fix known defects and incorporate product enhancements. To search for software updates for your product, go to the Agilent Technical Support website at www.agilent.com/find/TechSupport or <http://na.tm.agilent.com/fieldfox/>.

What's New in A.05.50 Release (Sept. 2011).....	6
Overview.....	7
Options and Features.....	7
Accessories.....	8
FieldFox Manuals, Software, and Supplemental Help.....	8
Preparing for Initial Use of Your New FieldFox.....	10
Check the Shipment.....	10
Meeting Power Requirements for the AC/DC Adapter.....	10
Install the Lithium-Ion Battery.....	11
FieldFox ON/OFF Settings.....	12
FieldFox High-Temperature Protection.....	12
Avoid Overpowering the FieldFox.....	13
Take the FieldFox Tour.....	14
Front Panel.....	15
Top Panel.....	16
Side Panel.....	16
Screen Tour.....	17
How to Enter Numeric Values.....	18
NA (Network Analyzer) Mode.....	19
CAT (Cable and Antenna Test) Mode - Option 305.....	33
CAT Mode Settings.....	34
Return Loss Measurements.....	39
1-Port Cable Loss Measurements.....	40
2-Port Insertion Loss Measurements.....	41
DTF (Distance to Fault) Measurements.....	42
DTF Measurement Settings.....	43
Calibration for NA, CAT, and VVM Modes.....	51
Verifying Calibration and Jumper Cable Integrity.....	60
Calibration Method Summary.....	61

Power Meter Mode	62
Power Meter Settings.....	63
VVM (Vector Voltmeter) Mode	68
Overview	69
VVM Mode Settings.....	70
1-Port Cable Trimming Measurements.....	73
2-Port Transmission Measurements.....	74
Data Analysis Features.....	76
All about Markers.....	76
All about Limit Lines	84
All about Trace Math.....	86
File Management.....	88
Saving and Recalling Files	88
Printing.....	94
System Settings.....	95
Run/Hold	95
Preset	96
Volume Control	96
Display Settings.....	97
Preferences.....	99
System Configuration	100
Service Diagnostics.....	105
Working with the Lithium-Ion Battery	107
Viewing Battery Charge Status.....	107
Charging the Battery.....	109
Reconditioning the Battery	110
Battery Care.....	111
Maximizing Battery Life.....	112
Lithium Ion Battery Disposal	112

Hardkey/Softkey Menus	113
Safety Considerations	120
Certification and Compliance Statements.....	133
Appendix A: Connector Care Review	135
Appendix B : Specifications/Data Sheet	136
Index.....	137

What's New in A.05.50 Release (Sept. 2011)

For customers upgrading FieldFox firmware, the following is a list of new features:

NA mode

Unwrapped Phase format	23
10,001 pts from front panel	28
Complex Impedance Marker Format.....	80
Marker Track, Target, and BW Search	80

System

Volume Control	96
GPS - decimal degrees format.....	101

Rev. November 10, 2011

This manual was updated with the following changes:

New MicroSD card slot images.....	16
Updated battery reconditioning procedure. ...	110

Overview

Options and Features

The FieldFox may be ordered to include the following options and features:

Options and Features	Learn more
RF Vector NA Mode <ul style="list-style-type: none">▪ 2 MHz to 4 GHz (Option 104)▪ 2 MHz to 6 GHz (Option 106)▪ Forward Measurements S11, S21▪ Full 2-port S-parameters (Option 122) Adds S22, S12 and Full 2-port Calibration.	NA Mode on page 19 Cal on page 51.
Cable and Antenna Test (CAT) Mode (Option 305) <ul style="list-style-type: none">▪ 2 MHz to 4 GHz (Option 104)▪ 2 MHz to 6 GHz (Option 106) Measurements: <ul style="list-style-type: none">▪ Distance-to-fault (DTF)▪ DTF & Return Loss▪ Return Loss (dB)▪ VSWR▪ DTF (VSWR)▪ Cable Loss (1-Port)▪ Insertion loss (2-Port)	CAT Mode on page 31
QuickCal (Option 112) Built-in cal kit. Industry first!	Cal on page 53
Power Meter Mode (Option 302) Use with Agilent External USB Power Sensors	Power Meter Mode on page 62
Vector Voltmeter (VVM) Mode (Option 308) Measure electrical length	VVM Mode on page 68
Measurements: <ul style="list-style-type: none">▪ 1-Port Cable Trimming (Mag and Phase)▪ 2-Port Transmission (Mag and Phase)	
Designed for Field Environment <ul style="list-style-type: none">▪ Lightweight 6.2 lbs (2.8 kg) including battery▪ Rugged, weather resistant shell with no fan/vents▪ Daylight viewable 6.5" (16.5 cm) color LCD▪ Backlit keys for night use▪ Integrated kickstand▪ Configurable hand and shoulder straps▪ Softcase for carrying all gear▪ Quick Reference Guide with laminated pages	

Slots for removable USB Flash Drive and micro SD Card <ul style="list-style-type: none"> ▪ Expands internal storage ▪ Useful for file transfer ▪ Flash Drive and micro SD Card not included ▪ FieldFox release 4.0 supports micro SDHC (high-capacity) Card 	Save / Recall on page 90
Battery or AC Power <ul style="list-style-type: none"> ▪ Rechargeable Li-Ion battery with ~4 hr life ▪ Easily removable battery ▪ AC/DC adapter ▪ External battery charger (N9910X–872) 	On page 107.
FieldFox Data Link Software <ul style="list-style-type: none"> ▪ Basic capability to print measurement traces on a PC. ▪ Capability to create/modify cal kit and cable definition files. ▪ Help file included with the software installation ▪ Download the latest version of the software at http://na.tm.agilent.com/fieldfox/datalink_info.html 	
Additional Features <ul style="list-style-type: none"> ▪ Menus localized to 7 languages 	Languages on page 99

Accessories

The following accessories are included with every N9923A FieldFox. Spare accessories can be ordered at any time.

Accessory Part Number	Description
8121-1351	Cable-Assembly Patch-5E RJ-45 Male/RJ-45 Male 7 FT-LG
N9910X–873	AC/DC Adapter
N9910X–870	Lithium-Ion Battery
N9910X–880	Softcase w/ Backpack & Shoulder Strap
N9910X–890	User's Guide (printed copy)
N9910X–891	Quick Reference Guide (printed copy)

To see a complete list of accessories that are available for the FieldFox, please visit: <http://www.agilent.com/find/fieldfox>.

FieldFox Manuals, Software, and Supplemental Help

The following manuals and software are available for the FieldFox. For the very latest version, please visit our website at: <http://www.agilent.com/find/fieldfox>. Check the manual revision on the first page of each manual.

- **User's Guide** – This manual, included with shipment.
- **Quick Reference Guide** – Printed copy with laminated pages for outdoor use, included with shipment.
- **Firmware Updates** – Check to see if you have the latest firmware at: <http://na.tm.agilent.com/fieldfox/>

- **FieldFox Data Link Software** - Free download at http://na.tm.agilent.com/fieldfox/datalink_info.html
- **Service Guide** – Free download available at <http://www.agilent.com/find/fieldfox>.
- **Supplemental Online Help** - Concepts and Reference information <http://na.tm.agilent.com/fieldfox/help/>

Conventions that are used in the Manual

- **Hardkey** indicates a front panel button. The functionality of these buttons does not change.

The six Softkey menus change dynamically and follow these color conventions:

- **Softkey** Blue indicates an available setting.
- **Softkey** Green indicates a change in menu level when selected.
- **Softkey** Black indicates the default or selected setting.
- **Softkey** Yellow indicates an active entry in process.
- **Softkey** Grey indicates a key that is NOT available.

Safety Notes

The following safety notes are used throughout this manual. Familiarize yourself with each of the notes and its meaning before operating this instrument. More pertinent safety notes for using this product are located in “Safety Considerations” on page 107.

CAUTION

Caution denotes a hazard. It calls attention to a procedure that, if not correctly performed or adhered to, could result in **damage to or destruction of the product**. Do not proceed beyond a caution notice until the indicated conditions are fully understood and met.

WARNING

Warning denotes a hazard. It calls attention to a procedure which, if not correctly performed or adhered to, could result in **injury or loss of life**. Do not proceed beyond a warning note until the indicated conditions are fully understood and met.

Preparing for Initial Use of Your New FieldFox

Check the Shipment

When you receive your FieldFox, check the shipment according to the following procedure:

1. Inspect the shipping container for damage. Signs of damage may include a dented or torn shipping container or cushioning material that indicates signs of unusual stress or compacting. If not damaged, **save the packaging material** in case the FieldFox needs to be returned.
2. Carefully remove the contents from the shipping container, and verify that the standard accessories and your ordered options are included in the shipment according to the Box Contents List.
3. For any question or problems, refer to Contacting Agilent on page 2.

Meeting Power Requirements for the AC/DC Adapter

Voltage: 100 VAC to 250 VAC

Frequency: 50 Hz to 60 Hz

Current: 1.25 – 0.56 A

The AC/DC adapter supplied with the analyzer is equipped with a three-wire power cord, in accordance with international safety standards. The power cable appropriate to the original product shipping location is included with the FieldFox.

Various AC power cables are available from Agilent that are unique to specific geographic areas. You can order additional AC power cables that are correct for use in different areas. For the power cord part number information please visit: <http://www.agilent.com/find/fieldfox>

Install the Lithium-Ion Battery



Step	Notes
1. Open the battery door.	Push the button on the battery compartment door while sliding the door outward.
2. Insert the battery.	The terminals end of the battery is inserted into the compartment.
3. Close the battery door.	Slide the battery compartment door upwards until it latches.

Battery Usage

When you receive your FieldFox, the lithium-ion battery is not installed, and it is partially charged to approximately 40% to preserve battery life. A lithium-ion battery has no memory effect, so it can be used partially charged, as shipped.

A fully charged battery will power your FieldFox for about four hours, so if you plan to use it for this long, you should fully charge the battery.

NOTE The FieldFox will shut down to prevent the battery from discharging to a level that is damaging. If this occurs, charge the battery either internally or externally. Learn more about the lithium-ion battery on page 107.

Battery charge status is viewable:

-  In the upper-right corner of the screen.
- On the Battery screen. To access the screen, select **System**, **Service**, **Diagnostics**, and **Battery**.
- On the battery. Open the FieldFox battery compartment door to view the battery LCD.

To conserve battery power:

- Use **Run/Hold** to single-trigger a measurement when needed. **Hold** is shown on the display.
- Press **System** then **Display** then **Brightness**. Use the **▲|▼** arrows, the rotary knob, or numeric keypad to adjust the brightness to dim the FieldFox display as much as possible.
- Briefly press the power button to switch to Stand By mode when the FieldFox is not being used. Press again to restore power. All current settings are preserved.

NOTE When powered by the battery only, the FieldFox can stay in Stand By mode for a maximum of four hours and then it powers off automatically. When the relative battery charge drops about 20%, the FieldFox will power off to preserve the remaining charge.

To recharge a battery:

Use ONLY a FieldFox charger to recharge a battery.

- The battery can be fully charged while in the FieldFox in about 4 hours with the FieldFox either ON or OFF.
- It can be fully charged externally using the external battery charger (Opt 872) in about 4 hours.

When the battery is removed, the FieldFox can still be powered by the AC/DC adapter.

FieldFox ON/OFF Settings

- To turn power **ON**, briefly press the power button. The LED is green. Boot-up takes about 1 minute.
- To switch to **Stand By** mode (low battery drain), briefly press the power button. The LED is orange and blinks. To turn power ON, briefly press the power button. Power and settings are restored instantly. See the Note above concerning Stand By mode.
- To turn Power **OFF** (very low battery drain), press and hold the power button until power is OFF - about 4 seconds. The LED is off.
- Data and instrument state are NOT automatically saved when the FieldFox is powered OFF. Learn how to save data and instrument state on page 88.

FieldFox High-Temperature Protection

The following features prevent degradation or damage in the event of high internal temperatures in the FieldFox.

NOTE Do NOT store the FieldFox in the softcase while powered ON or in Stand By mode.

How to monitor the internal FieldFox temperature:

- Press **System**, then **Service Diagnostics**.

- Then **Internal Temperatures**.

The temperature at which the following events occur is the average of the RF1, SB1, SB2 temperatures. These temperatures come from internal sensors embedded within FieldFox.

Temperature Control Mode

At approximately 73 °C, the FieldFox enters Temperature Control mode by reducing display intensity and measurement speed. This should decrease the internal temperature which preserves measurement accuracy and maintains the long-term reliability of the FieldFox.

When entering Temperature Control mode, save your instrument state and data that you want to keep.

When the temperature drops to approximately 71°C, normal operating settings are restored.

NOTE Measurement speed specifications do NOT apply in Temperature Control Mode.

High-Temp Shutdown

In extreme situations, Temperature Control mode may not stop an increase in the FieldFox internal temperature. At approximately 75°C, High-Temperature Shutdown will engage and turn OFF the FieldFox.

Just prior to shutdown, the FieldFox will display a warning of imminent shut down.

Avoid Overpowering the FieldFox

The FieldFox can be damaged with too much power or voltage applied. Exceeding the maximum RF power levels shown below will cause an **ADC Over Range** message to appear on the screen.

WARNING

Maximum Input Voltages and Power:

- **Port 1 or Port 2 Connector: ±50 VDC,
+23 dBm RF**
- **Exter Trig/Ref Connector: 5.5 VDC**
- **DC Input: 19 VDC,
4 ADC**
- **Power Sensor Input: +25 dBm (320 mW) average
+33 dBm peak (2 W) <10µs
+ 5 VDC**

NOTE Very often, coaxial cables and antennas build up a static charge, which, if allowed to discharge by connecting to the FieldFox, may damage the instrument input circuitry. To avoid such damage, it is recommended to dissipate any static charges by temporarily attaching a short to the cable or antenna prior to attaching to the FieldFox.

Take the FieldFox Tour

Front Panel



N9912_001_401

Front Panel

No.	Caption	Description	Learn More on Page:
1	Power	ON: press momentarily. STAND BY: with FieldFox power ON, press briefly. OFF: press and hold about 4 seconds until the FieldFox shuts off.	12
2	LED	Not lit: FieldFox OFF, not charging Green: FieldFox ON. Charging status indicated by battery icon on screen Orange, flashing: FieldFox STAND BY Orange, intensity increasing, flashing slowly: FieldFox OFF, charging	12
3	System	Displays a submenu for system setup	94
4	Function keys	Includes: Freq/Dist , Scale/Amptd , BW , Sweep , Trace , Meas Setup , Measure , and Mode	Refer to specific Mode.
5	Preset	Returns the analyzer to a known state	96
6	Enter	Confirms a parameter selection or configuration	--
7	Marker	Activates marker function	76
8	Mkr→/Tools	Displays a submenu for marker functions	79
9	Esc	Exits and closes the dialog box or clears the character input	--
10	Save/Recall	Saves the current trace or recalls saved data from memory	88
11	Limit	Sets limit lines for quick Pass/Fail judgment	84
12	Run/Hold	Toggles between free Run and Hold/Single operation.	95
13	Cal	Displays a submenu for calibration functions	51
14	Arrow keys	Increases or decreases a value or setting.	--
15	◀Back	Returns to the previous menu selection.	--
16	Rotary knob	Highlights an item for selection, or enables incremental changes to values.	--
17	Softkeys	Allows selection of settings for configuring and performing measurements, and for other FieldFox functions.	--
18	Screen	Transflective screen, viewable under all lighting conditions. If you are using your FieldFox in direct sunlight, you do not need to shield the display from the sunlight. In bright lighting conditions, the display is brighter and easier to read when you allow light to fall directly on the screen. Alternative color modes exist that maximize viewing in direct sunlight conditions, as well as other conditions such as nighttime work. Note: Clean the Transflective screen with gentle and minimal wiping using Isopropyl alcohol applied to a lint-free cloth.	96 - Display settings 17 - Screen Tour







Top Panel



Caption	Description	Learn More
Port 1	For CAT and NA measurements, contains source and A / R1 receivers. Maximum: ± 50 VDC, +23 dBm RF	CAT Mode on page 19 NA Mode on page 19
Ext Trig/Ext Ref	External Reference connector to connect to an external frequency reference. Maximum: 5.5 VDC. External Triggering is not used on the N9923A.	Ext Ref on page 101
Port 2	For CAT and NA mode, contains source and B / R2 receivers. Maximum: ± 50 VDC, +23 dBm RF.	CAT Mode on page 19 NA Mode on page 19

Side Panel



Caption	Description	Learn More
	Ethernet cable connector to read trace data using the FieldFox Data Link Software.	Data Link webpage
	Reserved for future use.	
	DC power connector used to connect to the AC/DC adapter. Maximum: 19 VDC, 4 ADC.	On page 11
	Micro Secure Digital slot. Use to extend the memory of the FieldFox.	File locations on page 88
	Standard USB connector used to connect a power sensor for Power Meter Mode. Also used to save files to a USB flash drive. Use of Keyboard and Mouse is NOT supported.	File locations on page 88
	Audio output jack.	

Screen Tour

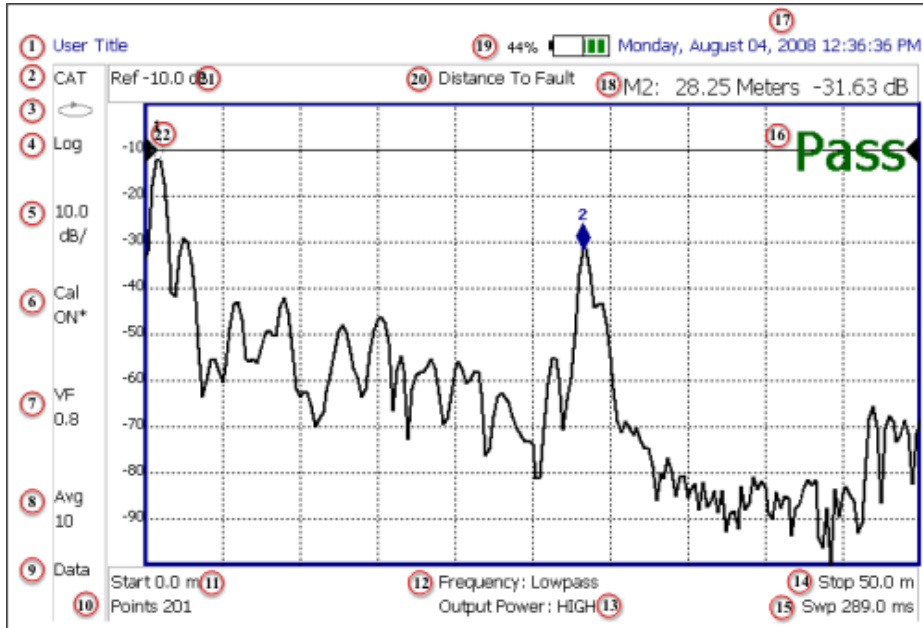

Caption	Description	Learn More on Page:
1	Title – write your own text here	98
2	Current Mode	
3	Run / Hold	95
4	Display Format	23
5	Scale/division	Mode dependent
6	Calibration Status (CAT and NA)	51
7	Velocity Factor (Fault Meas)	45
8	Averaging Status and Count	Mode dependent
9	Data / Mem Display (CAT and NA)	86- Trace Math
10	Resolution Setting	Mode dependent
11	Measurement Start Freq or Distance	Mode dependent
12	Bandpass / Lowpass setting (Fault Meas) IF BW in NA Mode	45
13	Output Power Level (CAT and NA)	38
14	Measurement Stop Freq or Distance	Mode dependent
15	Actual Sweep Time	Mode dependent
16	Limit Line Status	84
17	Time and Date	103
18	Marker Readout	76
19	Battery Status	107
20	Measurement Type (CAT and NA)	
21	Reference Level	Mode dependent
22	Reference Position	Mode dependent

How to Enter Numeric Values

Many settings on the FieldFox require the entry of numeric values.

How to enter numeric values

Use any combination of the following keys:

- Numeric 0–9 keys, along with the polarity (**+/-**) key.
- Up/Down arrow keys to increment or decrement values.
- Rotary knob to scroll through a set of values.
- **Back** erases previously entered values.
- **Esc** exits data entry without accepting the new value.

To complete the setting:

- Press **Enter** or a different **softkey** or **hardkey**.

Multiplier Abbreviations

Many times after entering numeric values, a set of multiplier or suffix softkeys are presented. The following explains the meaning of these abbreviations.

Select Frequency multipliers as follows:

- **GHz** Gigahertz (1e9 Hertz)
- **MHz** Megahertz (1e6 Hertz)
- **kHz** Kiloherz (1e3 Hertz)
- **Hz** Hertz

Select Time multipliers as follows:

- **s** Seconds
- **ms** milliseconds (1e-3)
- **us** microseconds (1e-6)
- **ns** nanoseconds (1e-9)
- **ps** picoseconds (1e-12)

NA (Network Analyzer) Mode

Learn more about NA Mode measurements in the FieldFox Supplemental Online Help: <http://na.tm.agilent.com/fieldfox/help/>

In this Chapter

How to Measure S-parameters	20
Receiver Measurements.....	21
Multi-Trace Configurations	21
Quick Settings	23
Format	23
Frequency Range	24
Scale Settings	25
Electrical Delay	25
Phase Offset.....	26
Averaging	25
IF Bandwidth.....	27
Smoothing	27
Single/Continuous	27
Resolution (number of points)	28
Sweep Time.....	28
Output Power	29
Interference Rejection	29
System Impedance.....	29
Port Extensions.....	30
Velocity Factor	31
Increase Dynamic Range	31

See Also

All about Calibration.....	51
Set Markers.....	76
Use Limit Lines	84
Use Trace Math	86

Making 75Ω (ohm) Measurements at the FieldFox Supplemental Online Help:
<http://na.tm.agilent.com/fieldfox/help/>

About S-parameters

S-parameters (scattering parameters) are used to describe the way a device modifies a signal. The FieldFox can measure **four S-parameters**. The syntax for each parameter is described by the following:

S (out | in)

out = FieldFox receiver port

in = FieldFox source port

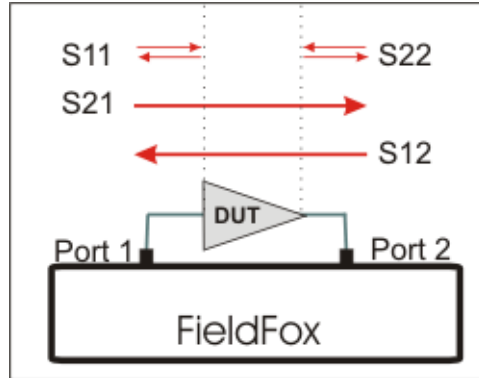

The FieldFox automatically switches the internal source and receivers to make both forward and reverse measurements. Therefore, the FieldFox can measure all four S-parameters with a single connection.

When the source comes from port 1, the measurement is said to be in the **forward** direction.

When the source comes from port 2, the measurement is said to be in the **reverse** direction, which requires Option 122.

S11 and S22 reflection measurements are used to measure the amount of reflections off the corresponding DUT port. Low reflections means there is a good impedance match between the source and DUT.

S21 and S12 transmission measurements are used to measure the loss or gain through a DUT over a specified frequency range. Both ends of the DUT must be connected to the FieldFox. The FieldFox signal source is transmitted out one of the test port connectors, through the DUT, and into the other test port connector.

How to measure S-parameters

1. Press **Preset** then **Preset**
2. Press **Measure 1** then choose from the following:
 - o **S11** Reflection measurement at port 1.
 - o **S21** Forward 2-port transmission measurement.
 - o **S12** Reverse 2-port transmission measurement. Requires Opt 122.
 - o **S22** Reflection measurement at port 2. Requires Opt 122.

OR select a multi-trace configuration. Learn more on page 21.

3. Press **Freq/Dist** then either **Start** and **Stop** or **Center** and **Span** to enter a Frequency Range for the measurement.
4. Press **BW 2** then **IFBW** to select the IF Bandwidth for the measurement. Narrower bandwidths require more time to sweep, but lowers trace noise.

5. Press **Sweep 3** then **Resolution** to select the number of data points for the measurement. More data points require more time to sweep.
6. Press **Cal 5** to calibrate the measurement. Learn more on page 51.
7. All other settings, described in the following section, can be made AFTER calibration without compromising measurement accuracy.

Receiver Measurements

In NA Mode ONLY, you can make unratioded, uncorrected receiver measurements. These measurements are typically used as diagnostic tools for service personnel.

NOTE The receivers measurements are NOT corrected for absolute power. They are only useful for making relative measurements. The Y-Axis and markers are labeled in dB - NOT dBm. Specifically, R1 and R2, do NOT indicate the actual power levels out of the source ports. The actual power levels are close to the typical output power of +6 dBm (High power) and -40 dBm (Low power).

How to make receiver measurements

- Press **Measure 1**
- Then **More**
- Then choose from the following:

A Port-1 test port (*1)	B Port-2 test port (*2)
R1 Port-1 reference receiver (*1)	R2 Port-2 reference receiver (*2)

(*) indicates the Auto-selected source port for the measurement

- **Source Port** The FieldFox port to provide the source signal. Choose from the following:
 - **Auto** The FieldFox sets the source port based on the selected receiver.
 - **Port 1** Select when measuring transmission at B receiver.
 - **Port 2** Select when measuring reverse transmission at A receiver.

Learn more about Raw Receiver Measurements at the FieldFox Supplemental Online Help: <http://na.tm.agilent.com/fieldfox/help/>

Multi-Trace Configurations

In NA Mode ONLY, you can display multiple traces on the FieldFox screen.

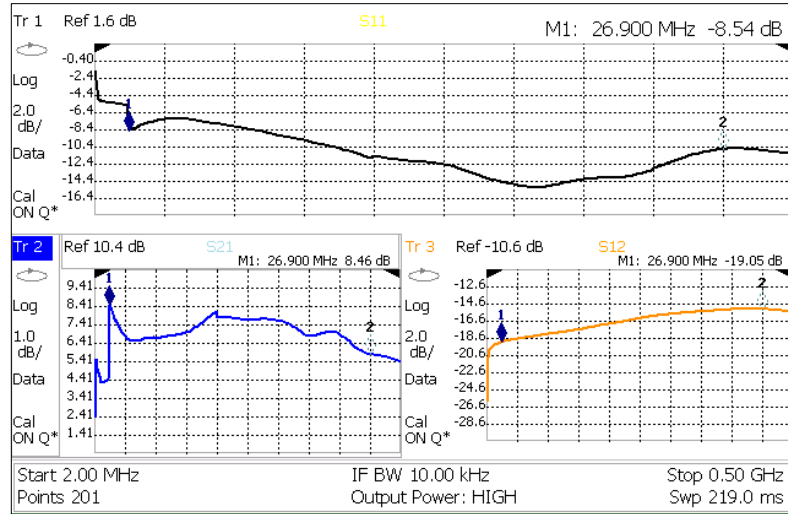

A 3-trace configuration. Tr2 is the ACTIVE trace as indicated by the highlighted **Tr 2**

Trace Setting Notes

- The Frequency Range, IF BW, Resolution, Average, and Output Power settings are common for all displayed traces.
- All other trace settings, such as measurement, format, and limit lines, are applied individually to the **ACTIVE** trace in the same manner as when a single trace is present.
- By default, a marker is created on ALL traces as show in the above image. However, they can be created individually by disabling Coupled Markers. Learn more on page 78.

How to select a multi-trace configuration

- Press **Trace 6**
- Then **Num Traces**
- Then choose from the following:
Default measurements shown in (parenthesis) depend on the options that are installed.
 - x1** 1 trace standard configuration (S11)
 - x2** 2 traces **overlayed** on a single graticule (S11, S21)
 - x2H** 2 traces on separate **horizontal** graticules (S11, S21)
 - x3H** 3 traces on separate **horizontal** graticules (S11, S21, S12)
 - x4** 4 traces on separate graticules (S11, S21, S12, S22)

How to activate a trace in order to change a setting

- Use the **▲/▼** arrows **OR**
- Press **Trace 6** then select **Trace 1**, **Trace 2**, **Trace 3**, or **Trace 4**. Only traces that are shown can be activated.

How to maximize the viewing of the active trace

- Press **System 7**
- Then **Full Screen**
- Press any key to return to the standard display.

Quick Settings

Both NA and CAT Modes allow you to view and change most relevant settings from a single location.

Setting	Value
Common Settings	
Start	2.000000 MHz
Stop	6.000000000 GHz
Center Frequency	3.001000000 GHz
Span	5.998000000 GHz
Resolution	201
Output Power	High
Average	4
Interference Rej.	Off
Number of Traces	x1
System zo	50
Trace 1 Settings	
Measurement	S11
Format	Log Mag
Trace 2 Settings	
Measurement	S21
Format	Log Mag

The Quick Settings menu. The resolution is being edited.

NOTE **Interference Rejection** and **System Z0** can be changed ONLY from the Quick Settings menu. Learn more about these settings on pages 29 and 29. ALL other settings can also be made using the standard softkey menus.

How to view and change Quick Settings

- Press **Meas Setup 4**.
- Then **Settings**.
- Press **Next Page** and **Previous Page** to view all settings. If these softkeys are NOT available, then all available settings fit on one page.
- To change a setting:
 - Use the **▲▼** arrows to highlight a setting.
 - Then press **Edit**. The current setting changes to **yellow**.
 - Some settings require you to press a softkey to change the value. Otherwise, use the numeric keypad, **▲▼** arrows, or rotary knob to change the value.
 - When finished changing a value, press **Done Edit**.
 - When finished changing settings, press **Done**.

Format

Select the display format in which to present measurement results. This setting can be changed at any time without affecting calibration accuracy.

NOTE Learn more about **Display Format** at the FieldFox Supplemental Online Help: <http://na.tm.agilent.com/fieldfox/help/>

How to select a NA Format

- Press **Measure 1**.
- Then **Format [current setting]**.
- Then choose from the following:
 - **Log Magnitude** Displays magnitude in dB
 - **Linear** Displays positive values only. Y-axis: Unitless (U) for ratioed measurements; Watts (W) for unratioed measurements.
 - **VSWR** Used mainly for S11 and S22. Displays unitless reflection data.
 - **Phase** Displays phase in degrees. The trace 'wraps' every 360 degrees, from +180 to -180, for easy scaling.
 - **Smith** Used mainly for S11 and S22. Displays series resistance and reactance.
 - **More** then...
 - **Polar** Used mainly for S11 and S22. Displays magnitude and phase of the reflection coefficient.
 - **Group Delay** Used mainly for S21 and S12. Displays signal transmission (propagation) time through a device in seconds. The Group Delay aperture is the current Smoothing aperture. Default is 1.5 % of the X-axis.
 - Learn how to set Smoothing aperture on page 27.
 - Learn more about Group Delay measurements at the FieldFox Supplemental Online Help: <http://na.tm.agilent.com/fieldfox/help/>

Unwrap Phase Same as Phase, but without 180 degree wrapping.

NOTE Phase is unwrapped by comparing the phase from one data point to the next. If the phase difference between two data points is greater than 180 degrees, or if the phase of the first data point is greater than 180 degrees from DC, than the phase measurement is probably NOT accurate. Increase the resolution setting to ensure that the phase measurement is accurate.

In Smith and Polar formats, marker format can be changed to display (Mag & Phase) or (R + jX). Learn how to set marker format on page 80.

Frequency Range

Set the range of frequencies over which you would like to make measurements. When the frequency range is changed after a calibration is performed, the cal becomes interpolated. Learn more on page 51.

How to set Frequency Range

This can be done in two ways:

- Press **Freq/Dist**
- Then choose from the following:

1. **Start** and **Stop** frequencies – Specify the beginning and end of the sweep.
2. **Center** and **Span** frequencies - Specify the center frequency and span of frequencies (half on either side of center).
 - Follow each by entering a value using the numeric keypad, the **▲|▼** arrows, or the rotary knob.
 - After using the **▲|▼** arrows or the rotary knob, press **Enter**. The increment setting of the arrows is based on the current span and can NOT be changed in NA Mode.
 - After using the keypad, select a multiplier key. Learn about multiplier abbreviations on page 18.

Scale Settings

Adjust the Y-axis scale to see the relevant portions of the data trace. The Y-axis is divided into 10 graticules.

This setting can be changed at any time without affecting calibration accuracy.

How to set Scale

- Press **Scale / Amptd**.
- Then choose from the following methods:
 1. **Autoscale** Adjusts the Y-axis to comfortably fit the Min and Max amplitude of the active trace.
 2. **Autoscale All** Autoscales all of the traces on the screen. Useful for multi-trace configurations.
 3. Set Scale, Reference Level, and Reference Position
 - **Scale** Manually enter a **scale per division** to view specific areas of the trace.
 - **Ref Level** Manually set the value of the reference line. Enter a negative value by pressing **Run/Hold (+/-)** either before or after typing a value.
 - **Ref Position** Manually set the position of the reference line. Values must be between 0 (TOP line) and 10 (BOTTOM line)

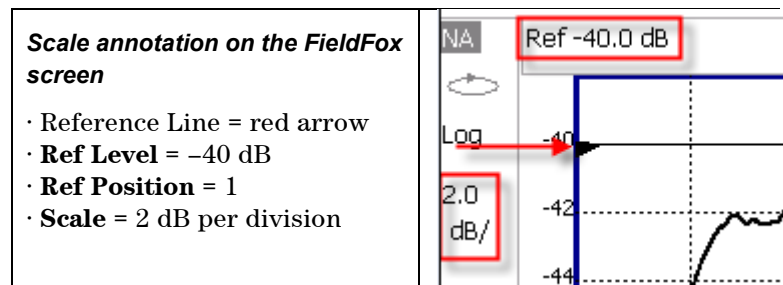

Electrical Delay

Electrical delay is a mathematical function that simulates a variable length of lossless transmission line. Use the electrical delay feature to compensate for the linear phase shift through a device and view only the deviation from linear phase of the device.

You can set the electrical delay independently for each measurement trace. To apply an electrical delay to all measurement traces, use Port Extensions. Learn how on page 30.

How to set Electrical Delay

- Press **Scale / Amptd**
- Then **More**
- Then **Electrical Delay**
- Enter a time value using the numeric keypad, the **▲▼** arrows, or the rotary knob.
- Press a multiplier key. Learn about multiplier abbreviations on page 18.

Phase Offset

Phase offset mathematically adjusts the phase measurement by a specified amount, up to 360°. Use this feature in the following ways:

Improve the display of a phase measurement. This is similar to the way you would change the reference level in an amplitude measurement. Change the phase response to center or align the response on the screen.

Emulate a projected phase shift in your measurement. For example, if you know that you need to add a cable and that the length of that cable will add a certain phase shift to your measurement, you can use phase offset to add that amount and simulate the complete device measurement.

You can set the phase offset independently for each measurement trace.

How to set Phase Offset

- Press **Scale / Amptd**
- Then **More**
- Then **Phase Offset**
- Enter a value in degrees using the numeric keypad, the **▲▼** arrows, or the rotary knob. Press **Enter**

Averaging

Trace Averaging helps to smooth a trace to reduce the effects of random noise on a measurement. The FieldFox computes each data point based on the average of the same data point over several consecutive sweeps.

Average Count determines the number of sweeps to average. The higher the average count, the greater the amount of noise reduction.

An average counter is shown in the left edge of the screen as **Avg N**. This shows the number of previous sweeps that have been averaged together to form the current trace. When the counter reaches the specified count, then a 'running average' of the last **N** sweeps is displayed.

Average Count = 1 means there is NO averaging.

This setting can be changed at any time without affecting calibration accuracy.

How to set Trace Averaging

- Press **BW 2**.
- Then **Average N** where N is the current count setting.
- Enter a value using the numeric keypad. Enter 1 for NO averaging.
- Press **Enter**.
- While Trace Averaging is in process, press **Sweep 3**, then **Restart**, to restart the averaging at 1.

IF Bandwidth

The FieldFox converts the received signal from its source to a lower intermediate frequency (IF). The bandwidth of the IF bandpass filter is adjustable. Reducing the IF receiver bandwidth reduces the effect of random noise on a measurement. However, narrower IF bandwidths cause longer sweep times.

How to set IF BW

- Press **BW 2**.
- Then **IF BW**
- Then choose from the following: **300 Hz | 1 kHz | 3 kHz | 10 kHz | 30 kHz**

Smoothing

Trace smoothing averages a number of **adjacent** data points to smooth the peak-to-peak noise values on a displayed trace. The number of adjacent data points that are averaged is known as the smoothing aperture. Aperture is set by specifying a percentage of the X-axis span.

Trace smoothing does NOT significantly increase measurement time.

Smoothing is used in Group Delay measurements, although it can be used with any NA format EXCEPT Polar or Smith Chart. Learn more about NA Mode formats, including Group Delay, on page 23.

When enabled, **Smo** appears on the FieldFox screen.

How to set Smoothing

- Press **BW 2**.
- Then **Smoothing ON OFF**
- Then **Sm. Aperture** and enter a value between 0 and 25 (percent) using the numeric keypad.
- Press **Enter**

Single or Continuous Measure

This setting determines whether the FieldFox measures continuously or only once each time the **Single** button is pressed. Use **Single** to conserve battery power or to allow you to save or analyze a specific measurement.

This setting can be changed at any time without affecting calibration accuracy.

How to set Single or Continuous

- Press **Sweep 3**.
- Then choose one of the following:
 - **Single** Automatically sets Continuous OFF and causes FieldFox to make ONE measurement, then hold for the next Single key press. When a data trace is displayed, the entire trace is measured, then holds. The **Hold** annotation changes to an arrow --> while the measurement occurs.
 - **Continuous ON OFF** Makes continuous measurements. This is the typical setting when battery power is not critical.

You can also use **Run / Hold +/-** to toggle between Single and Continuous.

Resolution (Number of Data Points)

Data points are individual measurements that are made and plotted across the X-axis to form a trace. Select more data points to increase measurement resolution. However, more data points requires more time to complete an entire measurement sweep.

When the Resolution is changed after a calibration is performed, the cal becomes interpolated. Learn more on page 51.

How to set Resolution

- Press **Sweep 3**.
- Then **Resolution**.
- Then choose from the following: **101 | 201 | 401 | 601 | 801 | 1001**.
- Using SCPI, Resolution can be set to any number of points between 3 and 10001. See the Programming Guide at <http://na.tm.agilent.com/fieldfox/help/>

Sweep Time

The fastest possible sweep time is always used as the default setting. Use the **Min Swp Time** setting to slow the sweep time when measuring long lengths of cable.

Learn more about measuring long cable lengths at the FieldFox Supplemental Online Help: <http://na.tm.agilent.com/fieldfox/help/>

The actual sweep time is shown on the FieldFox screen. See the Screen Tour on page 17. To increase the sweep time, enter a value that is higher than the actual sweep time. The increase will not be exactly the amount that you enter, as the actual sweep time is the composite of many factors.

NOTE Measurement speed specifications do NOT apply in Temperature Control Mode. Learn more on page 13.

How to set Sweep Time

- Press **Sweep 3**.
- Then **Min Swp Time**.
- Enter a value using the numeric keypad.
- Press a multiplier key. Learn about multiplier abbreviations on page 18.

Output Power

Set the power level out of the FieldFox to either High power or Low power. Generally, the high power level (default setting) is more accurate because the receivers are measuring farther from the noise floor. However, some devices are sensitive to high power levels. Use the Low power setting when measuring amplifiers.

NOTE To help prevent damage to your DUT, when Output Power is changed in NA Mode, it is changed to the same value in CAT Mode.

How to set Output Power

- Press **Meas Setup 4**.
- Then **Output Power High Low**.
 - **High** Sets output power to approximately +6 dBm.
 - **Low** Sets output power to approximately -40 dBm.

Interference Rejection

Use this setting when you suspect that other signals in the area are interfering with a measurement. This may look like a spike or lack of stability in the measurement trace. While monitoring a measurement at a specific frequency, toggle this setting between ON and OFF. If the measurement result decreases while ON, then there is an interfering signal in the area. Continue to make measurements with Interference Rejection ON. However, this will slow the measurement speed.

Once enabled, up to SIX sweeps may be required before the interfering signal is neutralized.

This setting can be changed at any time without affecting calibration accuracy.

How to set Interference Rejection

- Press **Meas Setup 4**.
- Then **Settings**
- Then scroll to **Interference Rej** and press **Edit**
- Then press **Interference Rej [current setting]** repeatedly to choose from the following:
 - **Off** No interference rejection and fastest possible sweep speed.
 - **Minimum** The lowest level of Interference rejection.
 - **Medium** The medium level of Interference rejection.
 - **Maximum** The highest level of Interference rejection.
- Press **Done Edit**

System Impedance (Z0)

To accurately view data presented in Smith Chart format, first set the System Impedance. Learn how to select Smith Chart format on page 23.

Learn how to make 75Ω measurements at the FieldFox Supplemental Online Help: <http://na.tm.agilent.com/fieldfox/help/>

How to set System Impedance

- Press **Meas Setup 4**.
- Then **Settings**
- Then scroll to **System zo** and press **Edit**.
- Then type either **50** or **75** and press **Enter**.

Port Extensions

Port extensions allow you to electrically move the calibration reference plane on either port 1 or port 2 after you have performed a calibration.

Why use Port Extensions

Use port extensions if you are unable to perform a calibration directly at your device because the location is not accessible. Perform a calibration at a convenient place, then use port extensions to compensate for the time delay (phase shift) to the desired reference plane. On the FieldFox, port extensions does not compensate for the loss of the additional electrical length, nor any mismatch errors beyond the calibration reference plane.

Also use port extensions if you have already performed a calibration, and then decide that you need to add a length of transmission line in the measurement configuration. Use port extensions to "tell" the FieldFox that you have added the length to a specific port..

- With S11 and S22 reflection measurements, the FieldFox doubles the port extension valued that you enter to account for the additional delay in the forward and reverse directions.
- With S21 and S12 transmission measurements, the port 1 and port 2 extensions are added together. This accounts for the total transmission delay going through ports 1 and 2.

Port extensions and Electrical Delay differ in the following ways:

- Electrical delay applies to a specific trace
- Port extensions apply to specific hardware ports

Port Extensions and Electrical Delay can be set independently. When both are set, the delay adds together. Learn more about Electrical Delay on page 25.

How to apply Port Extensions

- Press **Meas Setup 4**.
- Then **Port Extensions**
- Then **Port Extensions ON**
- Then **Port1 Extension** or **Port2 Extension**
- Then enter time value using the numeric keypad, the **▲▼** arrows, or the rotary knob. Press **Enter** or select a seconds (time) multiplier.

You can also set Port Extensions by pressing **Meas Setup 4** then **Calibration** (settings).

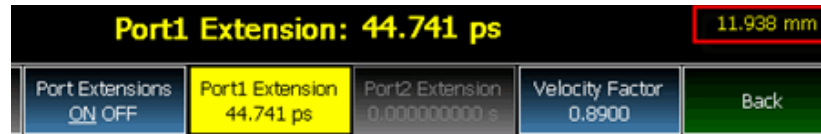

While setting Port Extension, the physical length of the extension (in meters ONLY), at the current Velocity Factor setting, is visible to the right (red box in above image).

Velocity Factor

The electrical delay or port extension value is entered as delay, or **electrical length**, in units of time.

Entering the velocity factor causes the FieldFox to accurately display the equivalent **physical length** in meters (NOT available in feet) that corresponds to the entered electrical delay.

Velocity factor is the ratio of the velocity of wave propagation in a coaxial cable to the velocity of wave propagation in free space. This velocity depends on the relative permittivity of the cable dielectric (ϵ_r).

$$\text{Velocity factor} = 1/\sqrt{\epsilon_r}$$

VF = 0.66 corresponds to wave propagation through a polyethylene dielectric.

VF = 1.0 (default setting) corresponds to wave propagation through free space (a vacuum).

How to set Velocity Factor

- Press **Meas Setup 4**.
- Then **Port Extensions**
- Then **Velocity Factor**
- Then enter a value between 0.1 and 1 using the numeric keypad, then press **Enter**.

You can also set Velocity Factor by pressing **Meas Setup 4** then **Calibration** (settings).

Increase Dynamic Range

Dynamic range is the difference between maximum input power to the FieldFox receiver (without compressing the receiver), and the minimum measurable power (noise floor). Measurement accuracy is increased when the DUT response is at least 10 dB above the noise floor. For a measurement to be valid, input signals must be within these boundaries.

A common application that requires a wide dynamic range is measuring the rejection band of a base station filter.

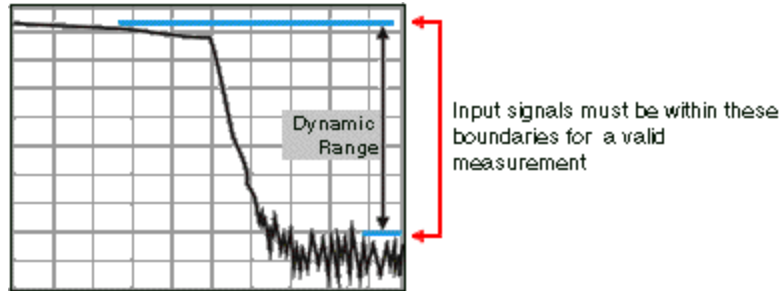

The following methods can help you increase the dynamic range.

- Perform a Full 2-port Calibration. Learn more on page 57. You can change the default CalReady calibration to a Full 2-port Calibration. Learn how on page 60.
- Use the High power setting. Press **Meas 4** then **Output Power High**
- Reduce the receiver noise floor. The following settings also reduce sweep speed.
 - Increase Averaging. Press **BW 2** then **Average** then choose a value.
 - Lower the IFBW. Press **BW 2** then **IF BW** then **300 Hz**

CAT (Cable and Antenna Test) Mode - Option 305

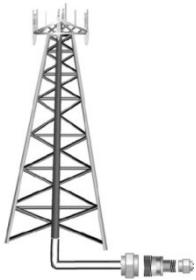

CAT Mode is typically used to test an entire transmission system, from the transmitter to the antenna. This process is sometimes referred to as Line Sweeping.

CAT Mode is similar to NA (Network Analyzer) Mode. Learn more at the FieldFox Supplemental Online Help: <http://na.tm.agilent.com/fieldfox/help/>

CAT Mode **Distance to Fault** measurements are discussed on page 42.

In this Chapter

Measurement Selection.....	34
Quick Settings	35
Frequency Range	35
Scale Settings	36
Averaging	37
Single/Continuous	37
Resolution	37
Sweep Time.....	38
Output Power	38
Interference Rejection	38

Procedures

Return Loss Measurement	39
1-Port Cable Loss Measurement.....	40
2-Port Insertion Loss Measurement	41
Distance to Fault Measurements.....	42

See Also

All about Calibration.....	51
Set Markers	76
Use Limit Lines	84
Use Trace Math	86

CAT Mode Settings

Select **CAT Mode** before making any setting in this chapter.

How to select CAT Mode

- Press **Mode**.
- Then **CAT**.

Measurement Selection

How to select a CAT Mode Measurement

Learn more about the following measurements

- Press **Measure 1**.
- Then choose one of the following: These softkeys also appear after CAT Mode is selected.
 - **Distance to Fault** 1-port reflection measurement that uses Inverse Fast Fourier Transform (IFFT) calculations to determine and display the distance to, and relative size of, a fault or disruption in the transmission line. Units are in return loss format, expressed as a positive number in dB, unless the measurement selected is DTF (VSWR). Learn more about DTF Measurements on page 42.
 - **Return Loss & DTF** Displays a Return Loss measurement in the top plot and a Distance to Fault measurement in the bottom plot. Use this format to display the frequency settings that are used to make the DTF measurement. Learn more about Bandpass Mode on page 44.

NOTE All plot settings, such as Scale, Markers, and so forth, are made to the DTF (bottom) plot, NOT to the Return Loss (top) plot. However, the frequency range of the Return Loss plot can be changed using the **Alternate Sweep** setting. Learn more on page on page 48.

- **Return Loss** 1-port reflection measurement that displays the amount of incident signal energy MINUS the amount of energy that is reflected. The higher the trace is on the screen, the more energy being reflected back to the FieldFox. Learn how to measure Return Loss on page 38.
- **VSWR** (Voltage Standing Wave Ratio – also known as SWR) 1-port reflection measurement that displays the ratio of the maximum reflected voltage over the minimum reflected voltage. The higher the trace is on the screen, the more energy being reflected back to the FieldFox. Learn more about VSWR at the FieldFox Supplemental Online Help: <http://na.tm.agilent.com/fieldfox/help/>
- **DTF (VSWR)** Distance to Fault in VSWR format.
- **More** Shows the following menu items:
- **1-Port Cable Loss** 1-port reflection measurement that displays the loss of a transmission line. Learn more on page 38.

- **2-Port Insertion Loss** 2-port transmission measurement that accurately displays the loss through a cable or other device in dB. Both ends of the cable must be connected to the FieldFox. NO phase information is included in this measurement. Learn more on page 41.

Quick Settings

Both CAT and NA Modes allow you to view and change most relevant settings from a single location. All of these settings are discussed in this chapter and, unless otherwise noted, ALL of these settings can also be made using the standard softkey menus.

How to view and change Quick Settings

- Press **Meas Setup 4**.
- Then **Settings**.
- Press **Next Page** and **Previous Page** to view all settings. If these softkeys are NOT available, then all available settings fit on one page.
- To change a setting:
 - Use the **▲▼** arrows to highlight a setting.
 - Then press **Edit**. The current setting changes to **yellow**.
 - Some settings require you to press a softkey to change the value. Otherwise, use the numeric keypad, **▲▼** arrows, or rotary knob to change the value.
 - When finished changing a value, press **Done Edit**.
 - When finished changing settings, press **Done**.

Use knob. Press [Edit] to make changes. Press [Done] to exit.

Setting	Value
Start Frequency	1.000000000 GHz
Stop Frequency	6.000000000 GHz
Center Frequency	3.500000000 GHz
Frequency Span	5.000000000 GHz
Resolution	201
Output Power	High

The Quick Settings menu. The resolution is being edited.

Frequency Range

Set the range of frequencies over which you would like to make CAT Mode measurements.

When the frequency range is changed after a calibration is performed, the cal becomes interpolated. Learn more on page 51.

How to set Frequency Range

- Press **Freq/Dist**.
- Then choose from the following:

- **Start** and **Stop** frequencies - beginning and end of the sweep.
- **Center** and **Freq Span** frequencies – the center frequency and span of frequencies (half on either side of center).
- Follow each setting by entering a value using the numeric keypad, **▲▼** arrows, or the rotary knob.
 - After using the keypad, select a multiplier key. Learn about multiplier abbreviations on page 18.
 - After using the **▲▼** arrows or the rotary knob, press **Enter**. The amount of frequency increment is based on the current span and can NOT be changed in CAT Mode.

Scale Settings

Adjust the Y-axis scale to see the relevant portions of the data trace. The Y-axis is divided into 10 graticules.

This setting can be changed at any time without affecting calibration accuracy.

How to set Scale

- Press **Scale / Amptd**.
- Then choose from the following three methods:
 1. **Autoscale** Automatically adjusts the Y-axis to comfortably fit the Min and Max amplitude of the trace on the screen.
 2. Set Scale, Reference Level, and Reference Position:
 - **Scale** Manually enter a **scale per division** to view specific areas of the trace.
 - **Ref Level** Manually set the value of the reference line. Enter a negative value by pressing **Run/Hold (+/-)** either before or after typing a value.
 - **Ref Position** Manually set the position of the reference line. Values must be between **0** (TOP line) and **10** (BOTTOM line)
 3. Set Top and Bottom graticule values. The scale per division is calculated.
 - **Top** to set the value of the Top graticule.
 - **Bottom** to set the value of the Bottom graticule.
 - Enter a negative value by pressing **Run/Hold (+/-)** either before or after typing a value.

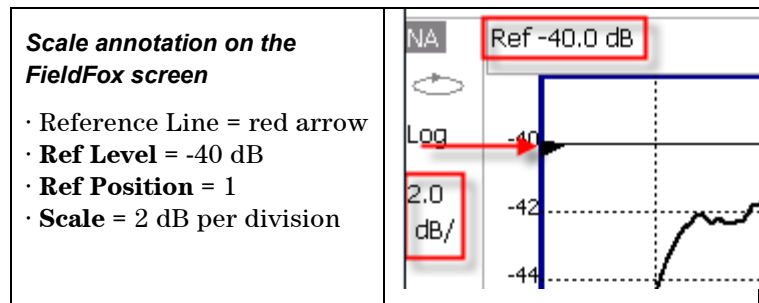

Averaging

Trace Averaging helps to smooth a trace to reduce the effects of random noise on a measurement. The FieldFox computes each data point based on the average of the same data point over several consecutive sweeps.

Average Count determines the number of sweeps to average. The higher the average count, the greater the amount of noise reduction.

An average counter is shown in the left edge of the screen as **Avg N**. This shows the number of previous sweeps that have been averaged together to form the current trace. When the counter reaches the specified count, then a 'running average' of the last **N** sweeps is displayed. Average Count = 1 means there is NO averaging.

This setting can be changed at any time without affecting calibration accuracy.

How to set Trace Averaging

- Press **BW 2**.
- Then **Average N** where **N** is the current count setting.
- Enter a value using the numeric keypad. Enter 1 for NO averaging.
- Press **Enter**.
- While Trace Averaging is in process, press **Sweep 3** then **Restart** to restart the averaging at 1.

Single or Continuous Measure

This setting determines whether the FieldFox measures continuously or only once each time the **Single** button is pressed. Use **Single** to conserve battery power or to allow you to save or analyze a specific measurement.

This setting can be changed at any time without affecting calibration accuracy.

How to set Single or Continuous

- Press **Sweep 3**.
- Then choose one of the following:
 - **Single** Automatically sets Continuous OFF and causes FieldFox to make ONE measurement, then hold for the next Single key press. When a data trace is displayed, the entire trace is measured, then holds. The **Hold** annotation changes to an arrow --> while the measurement occurs.
 - **Continuous ON OFF** Makes continuous measurements. This is the typical setting when battery power is not critical.
- You can also use **Run / Hold +/-** to toggle between Single and Continuous.

Resolution (Number of Data Points)

Data points are individual measurements that are made and plotted across the X-axis to form a trace. Select more data points to increase measurement resolution. However, more data points require more time to complete an entire measurement sweep.

When the Resolution is changed after a calibration is performed, the cal becomes interpolated. Learn more on page 51.

How to set Resolution

- Press **Sweep 3**.
- Then **Resolution**.
- Then choose one of the following: **101 | 201 | 401 | 601 | 801 | 1001**.
- Using SCPI, Resolution can be set to any number of points between 3 and 10001. See the Programming Guide at <http://na.tm.agilent.com/fieldfox/help/>

Sweep Time

The fastest possible sweep time is always used as the default setting. Use the **Min Swp Time** setting to slow the sweep time when measuring long lengths of cable. Learn more about measuring long cable lengths at the FieldFox Supplemental Online Help: <http://na.tm.agilent.com/fieldfox/help/>

The actual sweep time is shown on the FieldFox screen. See the Screen Tour on page 17. To increase the sweep time, enter a value that is higher than the actual sweep time. The increase will not be exactly the amount that you enter, as the actual sweep time is the composite of many factors.

NOTE Measurement speed specifications do NOT apply in Temperature Control Mode. Learn more on page 13.

How to set Sweep Time

- Press **Sweep 3**.
- Then **Min Swp Time**.
- Enter a value using the numeric keypad.
- Press a multiplier key. Learn about multiplier abbreviations on page 18.

Output Power

Set the power level out of the FieldFox to either High power or Low power. Generally, the high power level (default setting) is more accurate because the receivers are measuring farther from the noise floor. However, some devices are sensitive to high power levels. Use the Low power setting when measuring amplifiers.

NOTE To help prevent damage to your DUT, when Output Power is changed in CAT Mode, it is changed to the same value in NA Mode.

How to set Output Power

- Press **Meas Setup 4**.
- Then **Output Power High Low**. The underlined value is the current setting.
 - **High** Sets output power to approximately +6 dBm.
 - **Low** Sets output power to approximately -40 dBm.

Interference Rejection

Use this setting when you suspect that other signals in the area are interfering with a measurement. Interference may look like a spike or lack of stability in the measurement trace. While monitoring a measurement at a specific frequency, toggle this setting between ON and OFF. If the measurement result decreases while ON, then there is an interfering signal in the area. Continue to make measurements with Interference Rejection ON. However, this will slow the measurement speed.

Once enabled, up to SIX sweeps may be required before the interfering signal is neutralized.

This setting can be changed at any time without affecting calibration accuracy.

How to set Interference Rejection

- Press **Meas Setup 4**.
- Then **Interference Rejection [current setting]**.
- Then choose from the following:
 - **Off** No interference rejection and fastest possible sweep speed.
 - **Minimum** The lowest level of Interference rejection.
 - **Medium** The medium level of Interference rejection.
 - **Maximum** The highest level of Interference rejection.

Return Loss Measurements

Return loss can be thought of as the absolute value of the reflected power as compared to the incident power.

When measuring an OPEN or SHORT, all incident power is reflected and approximately 0 dB return loss is displayed.

When measuring a LOAD, very little power is reflected and values of 40 dB to 60 dB are displayed.

The minus sign is usually ignored when conveying return loss. For example, a component is said to have 18 dB return loss, rather than -18 dB.

How to measure Return Loss

- Connect the cable or any adapter used to connect the device under test (DUT).
- Select **Preset** then **Preset** Returns the FieldFox to known settings.
- Select **Mode** then **CAT** (Cable and Antenna Test)
- Then **Return Loss** (Default measurement).
- Press **Freq/Dist** and enter **Start** and **Stop** frequency values of the measurement.
- Press **Meas Setup 4** then **Settings** to make appropriate settings before calibrating.
- Disconnect the cable or DUT and press **Cal 5** then follow the calibration prompts.

- Reconnect the cable or DUT.
- The return loss trace is displayed on the FieldFox screen.

NOTE If the DUT just measured is a cable, and if you are now going to perform a 1-port cable loss measurement, save the return loss measurement data to memory. Doing this allows you to omit steps 10 and 11 on page 41 in the procedure for making a 1-port cable loss measurement.

1-Port Cable Loss Measurements

While all cables have inherent loss, weather and time will deteriorate cables and cause even more energy to be absorbed by the cable. This makes less power available to be transmitted.

A deteriorated cable is not usually apparent in a Distance to Fault measurement, where more obvious and dramatic problems are identified. A Cable Loss measurement is necessary to measure the accumulated losses throughout the length of the cable.

A 2-port Insertion Loss measurement is usually more accurate than a 1-port Cable Loss measurement. However, to perform a 2-port Insertion Loss measurement, both ends of the cable must be connected to the FieldFox.

NOTE In high-loss conditions, a Cable Loss measurement becomes ‘noisy’ as the test signal becomes indistinguishable in the FieldFox noise floor. This can occur when measuring a very long cable and using relatively high measurement frequencies. To help with this condition, use High Power (page 38), and Averaging. (page 37).

How to make a 1-port Cable Loss Measurement

4. Press **Preset** then **Preset**.
5. Then **More** then **Cable Loss (1-Port)**.
6. Connect the cable to be tested.
7. Press **Freq/Dist** and enter **Start** and **Stop** frequency values of the measurement.
8. Press **Sweep 3** then **Min Swp Time**. Increase the Sweep Time until a stable trace is visible on the screen. The amount of time that is required increases with longer cable lengths. Learn more about measuring long cable lengths at the FieldFox Supplemental Online Help: <http://na.tm.agilent.com/fieldfox/help/>
9. Remove the cable to be tested.
7. Press **Cal 5**, then **QuickCal** or **OSL**.
8. Follow the prompts to perform calibration at the end of the jumper cable or adapter. Learn more about Calibration on page 53.
9. Connect the cable to be tested.

NOTE Low-level standing waves (also known as ‘ripple’) which may be visible in reflection measurements, can hide the actual loss of the cable. Steps 10 through 13 can minimize the ripple. Perform the measurement with and without steps 10 through 13 and choose the method with the least amount of ripple.

10. Connect a LOAD at the end of the cable to be tested. This limits the reflections to faults that are located in the cable under test.
11. Press **Trace 6** then **Data->Mem** to store the trace into Memory.

12. Remove the LOAD and leave the end of the cable to be tested open.
13. Press **Data Math** then **Data – Mem**. The ripple in the measurement is removed. These minor imperfections in the cable should not be considered in the Cable Loss measurement.
14. Use Averaging to remove random noise from high-loss measurements. Press **BW 2** then **Average**.

The displayed trace shows the Cable Loss values in one direction through the cable. A Return Loss measurement would show the loss for both down the cable and back. Therefore, a Cable Loss measurement is the same as a Return Loss measurement divided by 2.

The average Cable Loss across the specified frequency range is shown on the screen below the graticules.

2-Port Insertion Loss Measurements

A 2-port Insertion Loss measurement is used to measure the loss through a DUT (device under test) – or cable – over a specified frequency range. The FieldFox signal source is transmitted out the PORT 1 connector, through the DUT, and into the PORT 2 connector. Both ends of the DUT must be connected to the FieldFox., either directly or indirectly using a jumper cable or adapter.

‘Insertion’ loss simply means **loss** through a device, usually expressed in dB. It is exactly the same measurement as “S21 Transmission” in NA Mode.

2-port Insertion Loss measurements are generally more accurate than 1-port Cable Loss measurements.

How to make a 2-port Insertion Loss Measurement

1. Press **Mode** then **CAT**.
2. Then **More** then **Insertion Loss (2-Port)**.
3. Press **Freq/Dist** and enter **Start** and **Stop** frequency values of the measurement.
4. Press **Sweep 3**, then select a **Resolution** setting.
5. Press **Cal 5**, then perform a calibration. Learn more on page 56.
6. Connect the DUT and view the insertion loss measurement results.

When measuring very long lengths of cable, it may be necessary to increase the sweep time. Learn more about measuring long cable lengths at the FieldFox Supplemental Online Help: <http://na.tm.agilent.com/fieldfox/help/>

DTF (Distance to Fault) Measurements

CAT Mode **Distance to Fault** (DTF) measurements are generally used to locate problems, or faults, in a length of cable or transmission line. In this chapter, the cable to be tested is referred to as the DUT (Device Under Test).

Settings that are NOT unique to DTF measurements are documented in the CAT Mode chapter on page 19.

In this Chapter

How to make DTF Measurements	42
DTF Start and Stop Distance	43
DTF Units	44
Bandpass Mode	44
Cable Specifications	45
Window Settings	45
Alternate Sweep	48
DTF Settings Page	49
About Alias Faults	49

Optional settings

Markers	76
Limit Lines	84
Save Measurement Settings and Results	88
Trace Math is NOT available in DTF Measurements.	

How to make DTF Measurements

Before starting, you may need the following:

- Jumper cable or adapter to connect the beginning of the DUT to the FieldFox.
 - LOAD with correct connector type and gender to terminate the end of the DUT (if possible).
 - The known length and cable type of the DUT. If the cable type is not known, then the Cable Loss (dB/Meter) and Velocity Factor of the DUT are required.
1. Connect any necessary jumper cable or adapter to the FieldFox **PORT 1**. Do NOT connect the DUT.
 2. Press **Preset** then **Preset** to return the FieldFox to the default settings.
 3. Then **Mode** then **CAT**.
 4. Then **Distance To Fault**.
 5. Press **Freq/Dist**, then **Stop Distance** and enter the length of the DUT. You can optionally set the **Start Distance**.
 6. Press **Cal 5** and follow the Cal prompts. Learn all about Calibration on page 51.

7. Disconnect any components or antenna that should NOT be measured and connect a LOAD at the end of the DUT.
8. Press **Meas Setup 4** then **DTF Cable Specifications**.
9. Either press **Recall Coax Cable**, or enter the **Velocity Factor** and **Cable Loss** of the DUT.
10. Connect the start end of the DUT to the FieldFox.
11. Press **Meas Setup 4** then **Settings** then **Next Page**. If the **Alias-free Range** setting is **False**, then you may see Alias faults on the screen. Learn more on page 49.

DTF Measurement Settings

You can set and view all of the DTF settings, including some calculated values, on the DTF Settings page. Learn more on page 49.

DTF Measurement (Format)

You can select from 3 different DTF Formats.

- Press **Measure 1**
- Then choose from:
 - **Distance to Fault (dB)** Faults are displayed on the Y-axis in return loss format, expressed as a positive number in dB.
 - **DTF (VSWR)** Faults are displayed on the Y-axis in SWR. Learn more about SWR at the FieldFox Supplemental Online Help: <http://na.tm.agilent.com/fieldfox/help/>
 - **More** then **DTF Lin** Faults are displayed on the Y-axis in linear (unitless) format.

DTF Start and Stop Distance

In DTF measurements, you set the physical length of cable or other device to be tested. The FieldFox calculates the frequency range of the measurement from this distance. The longer the cable to be tested, the lower the frequencies that are used. You can also set the frequencies manually using the Frequency Mode [Bandpass] setting.

How to set Start and Stop Distance

- With a DTF measurement present, press **Freq/Dist**.
- Then choose from the following:
 - **Start Distance** Enter a value using the numeric keypad, the **▲▼** arrows, or the rotary knob, then **Enter**. By default, the Start Distance is set to **0** Meters. This means that the measurement will display faults starting at the point at which calibration standards are connected.
 - **Stop Distance** Enter a value between the start distance and **5 km** (or 16,404 ft.) using the numeric keypad, the **▲▼** arrows, or the rotary knob, then **Enter**.

DTF Units

By default, X-axis units for DTF measurement settings are displayed in Meters.

How to change DTF units

- With a DTF measurement present, press **Freq/Dist**.
- Then **DTF Units**.
- The current selection is underlined **m (meters) Feet**.

Frequency Mode

All DTF measurements are made with frequency settings and, using Inverse Fast Fourier Transform (IFFT), the time and distance to faults are calculated.

How to set Frequency Mode

With a DTF measurement present,

- Press **Meas Setup 4**
- Then **Frequency Mode**
- Choose one of the following:
 - **Lowpass Mode** The frequency range of a DTF measurement is set automatically based on the Start and Stop Distances. Use Lowpass mode when the DUT is a cable ONLY.
 - **Bandpass Mode** (Default setting) The frequency range of a DTF measurement is set manually. Use Bandpass mode when the DUT contains a diplexer or other filtering device which does not pass some frequencies.

Typically, you will set the frequency range of the measurement to the passband of the filter. However, you may also want to test the ability of the filter to **reject** unwanted frequencies. In this case, set the frequency range to include those frequencies which the filter may not be adequately rejecting.

When the DTF frequencies are set manually, they may not be the optimum frequencies for measuring the distance to fault. The distance may no longer be alias-free. Learn more about alias-free range on page 49.

How to manually set Frequencies in Bandpass Mode

- Press **Freq/Dist**
- Then **Min Start Freq** and type the start of the frequency range to use for the DTF measurement.
- Then **Max Stop Freq** and type the stop frequency to use for the DTF measurement.

OR

- Press **More**
- Then **Max Freq Span** and type the frequency range to use for the DTF measurement.

- Then **Center Frequency** and type the center frequency of the range to use for the DTF measurement.

These settings specify the minimum and maximum frequencies to be used for the DTF measurement. These exact frequencies may not be used, but a narrower frequency range may be used that will still pass through the bandpass filter.

To see the frequencies that are used in the DTF measurement, press **Meas Setup** **4** then **Settings** then **Next Page**. The calculated Start and Stop frequencies determine the exact frequency range being used.

Cable (Correction) Specifications

By default, the FieldFox does NOT correct DTF measurements to account for the inherent loss of a cable. However, to make more accurate DTF measurements, the Cable Loss and Velocity Factor values should be considered.

About Velocity Factor and Cable Loss

- Velocity Factor is a property of the physical material of a cable. A VF of 1.0 corresponds to the speed of light in a vacuum, or the fastest VF possible. A polyethylene dielectric cable has VF = 0.66 and a cable with Teflon dielectric has VF = 0.7.
- Cable Loss is specified in dB/meter. In addition to the length of the cable, loss is also directly proportional to the frequency of the signal that passes through the cable.

The following is an example showing how DTF cable correction works:

The DUT is a 100 meter transmission cable. The Cable Loss value is .1 dB/meter. This means that a signal traveling ONE WAY through the cable will lose 10 dB of power ($100 \text{ m} * .1\text{dB/m}$). Because the FieldFox performs this measurement with 1 port, the test signal travels down the cable and then back, for a total loss of 20 dB.

After a calibration has been performed, for the purpose of illustrating this point, connect an OPEN to the end of the cable – a maximum-sized fault - for 100% reflection of the 300 MHz test signal.

Without compensation for the loss of the cable, a -20 dB response would be visible at 100 meters, which is the OPEN at the end of the DUT. This is from 10 dB of loss through the cable in each direction.

With compensation for the loss using the manufacturer's specification, the FieldFox compensates the trace as though the signal traveling through 100 meters was increased by +20 dB. Therefore the response will show 0 dB for 100% reflection.

How to enter Cable Loss and Velocity Factor

Cable Loss and Velocity factor can be entered using one of the following methods:

- Manually enter cable loss and velocity factor for the measurement.
- Select or create a cable file which contains the cable loss and velocity factor.

With a DTF measurement present:

- Press **Meas Setup** **4**.

- Then **DTF Cable Specifications**
- Select **Cable Corr**
 - **Auto** Use Cable Loss and Velocity Factor values from a Cable file. See “How to Edit, Save, and Recall a Cable File” below. This will overwrite a manually-entered value.
 - **Man** Manually enter a value for Cable Loss and Velocity Factor.
- Then:
 - **Velocity Factor** Using the numeric keypad, enter a value between 0.01 and 1. Then press **Enter**.
 - **Cable Loss** Using the numeric keypad, enter a positive Cable Loss value in dB/m, then press **Enter**.

How to Edit a Cable File

The FieldFox includes many predefined cable files with the manufacturer’s specifications. You can edit these files or create new cable files using the following procedure or using the FieldFox Data Link Software. Learn more at: http://na.tm.agilent.com/fieldfox/datalink_info.html

The Cable correction data survives a Mode Preset and Preset.

With a DTF measurement present:

- Press **Meas Setup 4**
- Then **DTF Cable Specifications**
- Then **Edit/Save/Recall Cables**
- Press **New** then **Yes** to clear all data from the existing DTF Cable table and reset header information to default settings.
- Then **Edit Cable** to open the Cable Editor.
- Then use the **▲|▼** arrows to select a field,
 - When editing Cable Description information, press **Edit** then modify the selected field using the FieldFox labeler.
 - When editing Frequency/Loss pairs, enter numbers using the numeric keypad, then select a frequency suffix. Then **Enter**. Learn more about “How the Freq/Loss pairs are applied” below.
- Optionally choose from the following:
 - **Previous / Next Page** Quickly scrolls through pages of Freq/Loss data.
 - **Add Data** Add a blank Freq/Loss pair to the table,
 - **Delete/Clear** then:
 - **Delete Line** Remove the selected Freq/Loss pair from the table.
 - **Clear All** then **Yes** Remove all Freq/Loss pairs from the table and resets header information to default settings.
- Press **Done** to close the Cable Editor.

How to Save or Recall a Cable

- Press **Save Cable** to save your changes to the specified Storage Device. Enter a filename using the FieldFox labeler (learn more on page 88). Learn more about Cable files below.
- Press **Recall Cable** to load a Cable file from the specified Storage Device.
- **Storage Device** Changes the device used to save or recall Cable files. This is a different setting from the Storage Device setting on the Save/Recall menu. Choose from **Internal** (default setting), **USB** (must be connected) or **SD card**.

About Cable files

- Cable files are saved to, and recalled from, the **Cables** folder. If the folder does not already exist on a USB or SD card, it is created automatically before storing the file.
- Cable files are stored as *.xml files. Existing cable files that are preloaded into the FieldFox firmware can be overwritten. Your edited file will NOT be overwritten when firmware is updated.

How the Freq/Loss pairs are applied

When the cable file contains one Freq/Loss pair, that correction value is applied to the entire displayed frequency span.

When the cable file contains two or more Freq/Loss pairs, the Loss value that is used is interpolated from the Freq/Loss pairs and the DTF center frequency. For example, using a cable file with the following Freq/Loss pairs:

1 GHz: 0.1 dB/m

2 GHz: 0.2 dB/m

The center frequency for the measurement is determined from the calculated (Stop – Start) frequency values (seen on the second page of DTF Settings):

Calculated Start = 2.0 MHz

Calculated Stop = 3.598 GHz

Center Freq = 1.80 GHz

The Loss value for the measurement is interpolated from the Freq/Loss pairs at the Center Freq:

1 GHz = 0.1 dB/m

1.8 GHz = 0.18 dB/m

2 GHz = 0.2 dB/m

The correction for loss at 5 meters in one direction: $0.18 \text{ dB/m} * 5\text{m} = 0.9 \text{ dB}$.

All DTF measurements correct for loss for travel down the DUT and back, so double the correction: $0.9 \text{ dB} * 2 = 1.8 \text{ dB}$.

Window Settings

Window settings provide the ability to choose between optimizing DTF measurements for resolving closely-spaced faults or for the ability to measure low-level faults.

How to select Window settings

- Press **Meas Setup 4**.
- Then **Settings**.
- Then press **▲|▼** arrows to move to the Window row.
- Then press **Edit**.
- Then press **Window** repeatedly and choose from the following:
 - **Maximum – Optimized for dynamic range**, the noise floor is lowered to provide the ability to measure low-level responses. (Default setting)
 - **Medium** – Compromise between Min and Max window settings.
 - **Minimum – Best Response Resolution**, providing the ability to resolve between two closely-spaced responses.
- Then press **Done Edit**.
- Again press **Done**.

Alternate Sweep

Available ONLY in a **Return Loss & DTF** measurement.

With Alternate Sweep ON, two independent sweeps are performed:

- Return Loss measurement sweep (Top plot).
- DTF measurement sweep (Bottom plot).

With Alternate Sweep OFF, only one sweep is made for both the Return Loss and DTF measurement.

How to set Alternate Sweep

- Press **Mode** then **CAT**.
- Then **Return Loss & DTF**.
- Then **Meas Setup 4**.
- Then **Alternate Sweep ON OFF**.

With Alternate Sweep ON, the Start and Stop frequency settings can be changed from the settings that are required to make the DTF measurement. However, the DTF measurement continues to be made using the frequencies that are dictated by the **DTF Bandpass Mode** setting. Learn more on page 44.

If a calibration is performed, it is applied to both sweeps.

How to set Start and Stop Frequency with Alternate Sweep ON

- Press **Freq/Dist**.
- Then **Start Frequency** and **Stop Frequency**.
 - Follow each by entering a value using the numeric keypad, **▲|▼** arrows, or the rotary knob.

- After using the **▲|▼** arrows or the rotary knob, press **Enter**. The increment setting of the arrows is based on the current span and can NOT be changed in CAT Mode.
- After using the keypad, select a multiplier key. Learn about multiplier abbreviations on page 18.

DTF Settings Page

You can set and view all of the DTF settings, including some calculated values, on the DTF Settings page.

- Press **Meas Setup 4**.
- Then **Settings**.
- Then press **▲|▼** arrows to move to a setting. If the setting can be changed, the **Edit** key is available.

Calculated DTF values

Press **Next Page** to view the following **calculated values**:

c - Start Frequency – Start frequency that is used to calculate DTF.

c - Stop Frequency – Stop frequency that is used to calculate DTF.

c - Range Resolution. Indicates the accuracy of the distance to fault measurement. For example, with range resolution of 500 mm, if the distance to fault is 10 meters, this value could be inaccurate by +/- 500 mm or between 9.5 to 10.5 meters. This value is calculated from frequency span / resolution (points).

Response Resolution, not displayed, indicates the distance that could be between two faults and still show as separate faults. Learn more in Window Settings on page 45.

c - Maximum Distance. The distance that could be viewed with the current settings. Defined by: $Vf * c * Points / (2 * Bandwidth)$ where:

- Vf = velocity factor
- c = speed of light
- Points = resolution
- Bandwidth = frequency range

c - Alias-free Range (True/False)

- ON = No Alias images
- OFF = Alias images MAY appear in the response.

About Alias Faults

An alias fault is not a true device response. An alias fault appears because of the method used to convert frequency to time.

On the DTF Settings page (above) the **c - Alias-free Range = Off** setting indicates alias images MAY appear on the screen.

Shorter stop distances (less than 10 meters) and a higher resolution (1001 points) will be **more** likely to result in **Alias-free Range = Off**.

When the Alias-free Range = Off, the following procedure will help to determine if a response is true or an alias response:

1. Put a marker on the response in question and note the distance to the fault.
2. Change the start or stop distance.

A true fault response will not move in distance. That is, if a true fault is present at 10.3 meters, changing the stop distance from 15 m to 20 m will not move the fault; the fault will remain at 10.3 meters. However, an alias response will appear to move.

An un-terminated cable (with NO perfect load at the end) will show faults that appear to be beyond the end of the cable. These are NOT alias faults. These faults appear as the signal reflects off the open at the end of the cable and travels back down the cable toward the connection at the FieldFox. Re-reflections are measured at the FieldFox as mirror images of the original faults. The largest fault is the open end of the cable. To avoid confusion, set the Stop distance shortly after that fault.

Calibration for NA, CAT, and VVM Modes

Calibration removes the systematic errors that are associated with measurements in NA, CAT, and VVM Modes. Key presses are identical in all of these Modes.

In this Chapter

Why and When to Calibrate	51
Definitions	51
CalReady	52
How to Perform a Calibration	52
QuickCal	53
Mechanical Cal	54
Response Cal	56
View Cal	57
Calibration Type	57
Interpolation.....	59
Questionable Accuracy	59
Compatible Mode Calibrations.....	59
Save a Calibration	59
CalReady Properties.....	60
Verify Calibration	60
Calibration Method Summary	61

See Also

Learn **How to Make 75 ohm Measurements** at the FieldFox Supplemental Online Help: <http://na.tm.agilent.com/fieldfox/help/>

Why and When to Calibrate

There are well-defined and understood systematic errors that are measured and calculated during the calibration process. These errors are caused by leakage signals inside the FieldFox, by the frequency response of the FieldFox receivers, and by reflections inside the FieldFox that interact with the DUT. After calibration, these errors are removed from subsequent measurements.

To maintain highest measurement accuracy, perform a new calibration when any of the following changes occur:

- When any of the following measurement settings change: Frequency Range, Power Level, IF BW, and Resolution. Therefore, make these measurement settings before calibrating. Increased Averaging, lower IF BW, and higher Resolution all cause slower sweeps and slower calibration times. Learn about Interpolation and Questionable Accuracy on page 59.
- When the FieldFox temperature changes more than about 10°F (5°C). Learn how to monitor the internal temperature on page 12.
- When the connection to the DUT changes, requiring a different jumper cable or adapter.

Definitions

DUT (Device Under Test) The cable, antenna, transmission line, amplifier, or anything else that is connected to the FieldFox that is to be measured.

Calibration Standards - OPEN, SHORT, LOAD, and THRU

- **OPEN, SHORT, and LOAD** are ‘reflection’ standards that are used during calibration. When an RF signal ‘hits’ these components, the signals are reflected in a predictable manner. These components can also be used to terminate a DUT port during some measurements.
 - SHORT and OPEN standards both cause 100% of an RF signal to be reflected. The difference between these two standards is what happens to the phase of the reflected signal, which is beyond the scope of this discussion. Although an OPEN standard is a precision component, simply leaving **nothing** connected at the end of a cable can be a reasonable substitute for an OPEN.
 - A LOAD standard absorbs almost ALL of the incident signal and very little signal is reflected back to the source.
- A THRU standard is used during some calibration steps to connect PORT 1 to PORT 2 in place of the DUT. A Flush THRU connection can be made when cables that connect with the DUT can mate with each other. Learn more on page 57. Otherwise, any reasonably short cable can be used as a THRU standard.

Calibration Reference Plane is the point (or points) at which the DUT and cal standards are connected during a calibration. This can be at the FieldFox test port connectors, or at the end of jumper cables or adapters.

CalReady

Every FieldFox contains a factory calibration that was performed at the port 1 and port 2 connectors over the entire frequency range of the FieldFox using a number of data points that allows reasonable interpolation over the FieldFox frequency range. This calibration, known as CalReady, allows you to immediately make accurate measurements for a DUT that is connected directly at the test ports (PORT 1 and/or PORT 2). CalReady corrects measurements when the FieldFox is turned ON, when Preset is pressed, and when a measurement is created with no other correction in place.

When measuring a DUT using a jumper cable or adapter - NOT a direct connection to a test port connector – then for highest accuracy a QuickCal or Mechanical Cal is recommended. CalReady can also be used to check the integrity of the jumper cable that is attached to the test ports.

CalRdy is shown when a measurement is corrected using CalReady.

You can change the properties of the CalReady calibration. Learn more on page 60.

How to Perform a Calibration

In CAT, NA, or VVM Mode, press **Cal 5**.

The following appears:

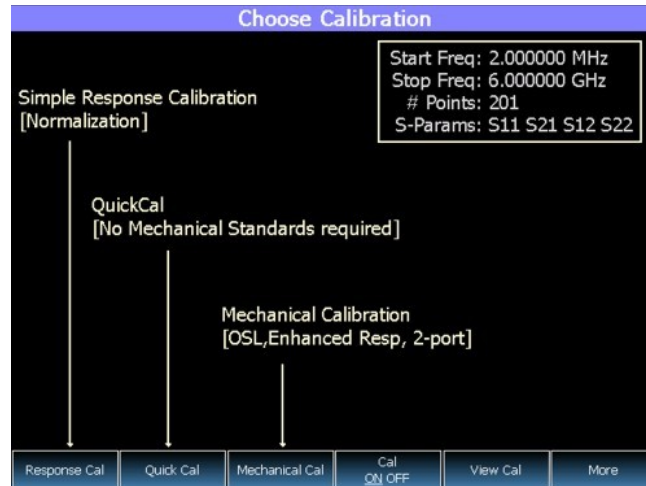

Choose Calibration Method screen

Response Cal – Used to quickly calibrate ONE measurement using mechanical standards. Measurement accuracy is generally low. Learn more on page 56.

Quick Cal (Option 112) – Using built-in cal standards, quickly and accurately cal measurements when using a jumper cable or adapter to connect the DUT to the FieldFox test ports. Learn more on page 53.

Mechanical Cal – Using mechanical cal standards from a cal kit, perform an accurate calibration at one or both test ports, adapters, or jumper cables. Learn more on page 54.

Cal ON OFF – Turns ON and OFF the effects of a calibration that you performed. The OFF state reverts to CalReady which can never be turned OFF.

View Cal – Shows the properties of the current calibration. Learn more on page 57.

More – Learn about Cal Ready Properties on page 60.

NOTE Press **Esc** at any time to end the calibration process.

QuickCal (Option 112)

QuickCal is ideal for calibrating measurements when using a jumper cable or adapter to connect the DUT to the FieldFox test ports. QuickCal corrects for phase shift, time delay, and loss of adapters or jumper cables.

How to perform a QuickCal

- In CAT, NA, or VVM Mode, press **Cal 5**.
- Then **QuickCal**
 - Press **Change DUT Connectors** to select the correct connector types that are on your DUT. Although there is no Cal Kit required, selecting the connector type and gender from the list provides an accurate OPEN model which means a more accurate calibration. If the DUT connector type is not listed, select **Unknown/Other**.
- For each DUT port:
 - Select the connector type of the DUT using the **▲|▼** arrows or rotary knob.

- Press **Change Gender** to change the gender of the DUT connector.
- Then press **Next...** to make the selection.
- **Select/Change Cal Type.** The FieldFox always RECOMMENDS a Cal Type that will quickly and accurately calibrate all of the displayed S-parameters. The other Cal Types that are listed will NOT necessarily calibrate all of the displayed S-parameters. Learn more about Cal Types on page 57.
 - Using the **▲|▼** arrows or rotary knob, select a Cal Type, then press **Select and Finish**.
- Press **Start Calibration**

No Connection

- Disconnect the DUT from the FieldFox.
- If a jumper cable or adapter is required to connect the DUT to the FieldFox, connect those components to the FieldFox test ports connectors. The effects of those components will be measured and removed during the calibration, and only the effects of the DUT will be displayed in the measurement results. These should be high-quality components!
- Do NOT connect anything at the cal reference plane where the DUT connects.
- Press **Measure**

Optionally Connect Load(s)

- Optionally connect a LOAD standard at the point where the DUT will be connected. Then press **Measure**.
- Attach and measure Loads when:
 - A jumper cable or adapter is used to connect the DUT to the FieldFox.
 - Measuring a DUT with good match (return loss > 15 dB).
- Otherwise, or when making DTF measurements, press **Skip Step**. Measuring a load would do little to improve accuracy.

Connect THRU (Not used for 1-port cals)

- Connect port 1 to port 2, either by mating the connectors that attach to the DUT (Flush THRU), or by using a short jumper cable. Learn more about Flush THRU on page 57. Then press **Measure**.
- Press **Finish**.

CAL ON Q is shown on the screen for all displayed measurements that are corrected with QuickCal.

Mechanical Cal

Mechanical Calibration is performed using discrete standards from a Cal Kit. Several Cal Kit definitions are built into the FieldFox.

For a complete list of supported Cal Kits, see the FieldFox specifications, beginning on page 136.

NOTE You can edit these Cal Kit definitions or add a new Cal Kit using the DataLink software, available at: http://na.tm.agilent.com/fieldfox/datalink_info.html

Mechanical Cals are extremely accurate when performed using the correct Cal Kits with standards that are clean and in good repair, and when using correct connection procedures.

How to perform a Mechanical Cal

- Disconnect the DUT from the FieldFox.
- If a jumper cable or adapter is required to connect the DUT to the FieldFox, then connect **those** components to the FieldFox connectors. The effects of those components will be measured and removed during the calibration, and only the effects of the DUT will be displayed in the measurement results. **These should be high-quality components!**
- In NA, CAT, or VVM Mode, press **Cal 5**.
- Then **Mechanical Cal**

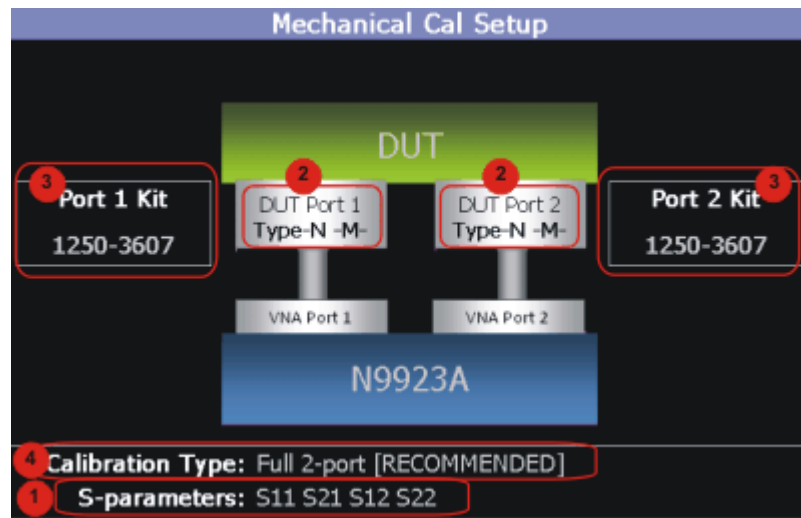

This page summarizes the Mechanical Cal to be performed and allows you to make changes. For best results, review the screen and make changes in the following order:

1. **S-parameters** – Verify that these are all of the S-parameters that you want calibrated. If not, press **Esc** to terminate the calibration process, then return to the Trace menu to display all of the traces to be calibrated. Learn how on page 21.
2. **DUT Connectors** – For each DUT port that is shown, verify the correct type and gender of the DUT connector. If a DUT port is not shown, then that port is not included in the list of S-parameters to be calibrated.
3. **Cal Kit** - Verify the correct Cal Kit for each DUT port to be calibrated. See a list of supported Cal Kits in the N9923A Data Sheet. See page 136.

If the DUT connector type, gender, or Cal Kit is **NOT** correct for the DUT ports to be calibrated, then:

- Press **Change DUT Connectors** to select the correct connector types that are on your DUT.
- For each port:

- Use the **▲▼** arrows or rotary knob to change the DUT connector type.
 - Press **Change Gender** to change the gender of the DUT connector.
 - Then press **Next...** to make the selections.
 - For each port:
 - Use the **▲▼** arrows or rotary knob to select the Cal Kit that you have, and are going to use, for the specified ports.
 - Then press **Next...** to make the selection.
4. **Calibration Type** - The FieldFox always RECOMMENDS a Cal Type that will quickly and accurately calibrate all of the displayed S-parameters. Change from the RECOMMENDED Cal Type ONLY if you understand the implications. Learn more about Cal Types on page 57.

To select a different Cal Type:

- Press **Change Cal Type**.
- Then using the **▲▼** arrows or rotary knob, select a Cal Type,
- Then press **Select and Finish**.

Press **Start Calibration**.

- Follow the Cal Wizard prompts. Connect the specified standard at the point where the DUT will be connected, then press **Measure**.
- At any time, press **Back** to Re-Measure a standard if you feel it was not properly connected.
- Press **Finish** to complete the calibration.

CAL ON U is shown on the screen for all displayed measurements that are corrected with the Mechanical Cal.

Response Cals

Response Cals are used to quickly calibrate the magnitude (not phase) of a measurement using mechanical standards. Measurement accuracy is generally low. Use a Response Cal to make quick measurements when using a jumper cable to connect the DUT to the FieldFox. Otherwise, CalReady is usually more accurate.

NOTE You can perform a Response Cal for either: S11, S22, or S21 AND S12.

When prompted, choose a standard based on the displayed measurements to be calibrated. For example, to calibrate S11, connect either an OPEN or SHORT standard to the port 1 reference plane.

Normalize uses a THRU standard or cable between port 1 and port 2 to cal an S21 and S12 Transmission measurement (NA Mode) and a 2-port Insertion Loss measurement (CAT Mode). In VVM Mode, this is performed using **Zero**.

How to perform a Response Cal

- Select the measurements to be calibrated. See the relevant Mode (NA, CAT, or VVM) for measurement selections.
- Press **Cal 5** then **Response Cal**
- For 1-port measurements:

- Select either **Open Response** or **Short Response** for the port to be calibrated. Port 2 is available only with Option 122.
- Connect an OPEN or SHORT standard to the specified port and press **Measure**
- For 2-port measurements:
 - Select **Normalization**
 - Connect a short, high-quality, phase stable cable between the FieldFox port 1 and port 2 connectors, then press **Measure**

NOTE With a Normalization Cal, all subsequent insertion loss measurements are made relative to the insertion loss of the THRU cable. For example, if you use a cable with 1 dB of loss, then after Normalization, the display will show 0 dB of loss with this cable in place. Therefore, for highest accuracy, when measuring the DUT also attach the cable that was used in the normalization cal.

- Press **Finish**.
- Connect the DUT.

CAL ON U is shown on the screen when a Response Cal is correcting ONLY the appropriate measurement.

View Cal

From the **Choose Calibration** screen (page 52), press **View Cal** to see the following screen:

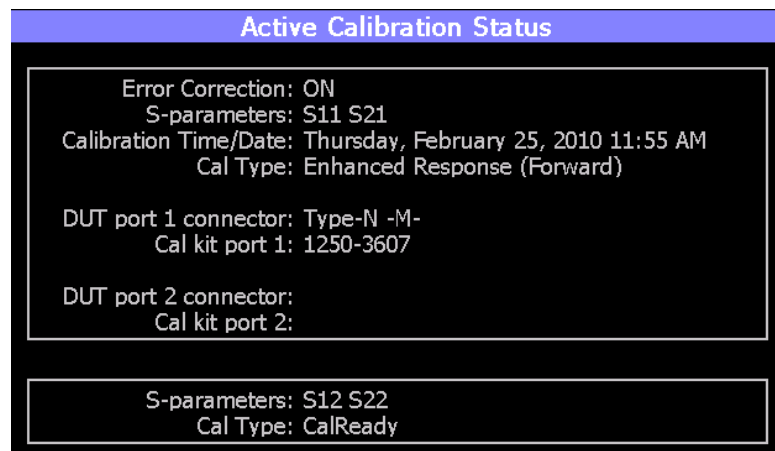

The top box shows the properties of the current calibration that you performed and the displayed S-parameters that it is correcting.

The bottom box shows the S-parameters that are displayed but NOT corrected by the current performed calibration, but rather the CalReady calibration. Learn more about CalReady on page 52.

Calibration Type

The FieldFox simplifies the calibration process by recommending the most accurate and efficient calibration type based on the displayed S-parameters.

However, there may be times when you may want a little more accuracy or a little faster sweep time. The following information can help you learn about the various calibration choices.

Definitions:

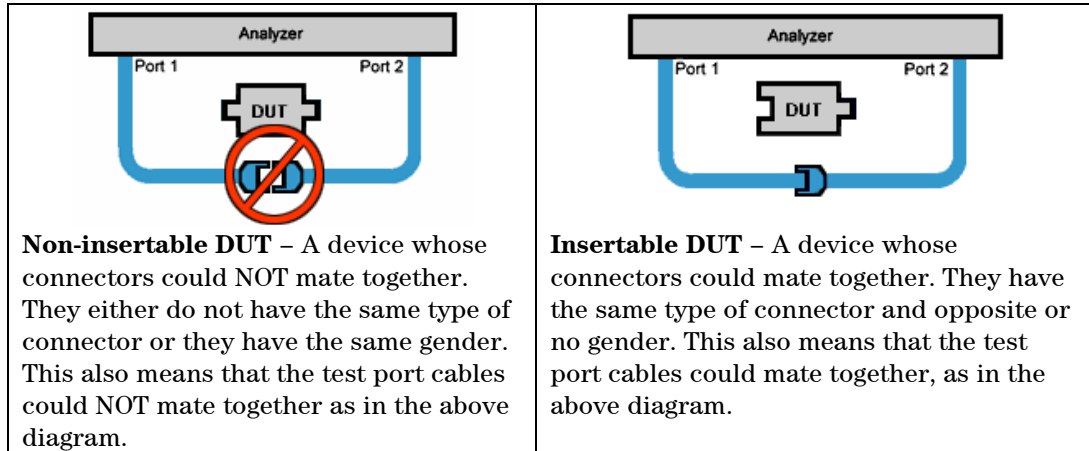

Flush THRU - When the test port cables mate together when measuring an **Insertable DUT**. The THRU standard has no loss and no electrical length.

Sweep Directions – Both FULL 2-Port Cals listed below result in correction that requires background measurements sweeps in both directions, regardless of the displayed measurements. The displayed traces are updated at a slower rate than Enhanced Response and 1-port calibrations, which require sweeps in one direction only.

FULL 2-Port (Available with Option 122).

Most comprehensive calibration. Corrects all S-parameters.

DUT: Non-Insertable or Insertable

Standards: OPEN, SHORT, LOAD on **BOTH** ports. Any THRU between ports.

For more information on the Unknown Thru process, see the FieldFox Supplemental Online Help: <http://na.tm.agilent.com/fieldfox/help/>

Sweeps in **BOTH** directions.

FULL 2-Port (QSOLT) – Mechanical Cal ONLY (Available with Option 122)

Quicker to perform than Full 2-port. Corrects all S-parameters.

DUT: Insertable only

Standards: OPEN, SHORT, LOAD on port 1. Flush THRU between ports.

Sweeps in **BOTH** directions.

Enhanced Response Cal (Forward OR Reverse with Option 122)

Faster measurements than Full 2-Port.

DUT: Insertable only

S-parameters Corrected: S21 and S11 (Forward) **OR** S12 and S22 (Reverse)

Standards: OPEN, SHORT, LOAD on **ONE** port. Flush THRU between ports.

Sweeps in ONE direction.

1-Port (OSL)

DUT: Not Applicable

S-parameters Corrected: S11 or S22

Standards: OPEN, SHORT, LOAD

Sweeps in ONE direction.

Interpolation *

Highest measurement accuracy is achieved when the frequency range or resolution settings remain the same during the measurement as when the FieldFox was calibrated. If these settings change after performing a calibration, the FieldFox will interpolate the calibration so that VERY accurate measurements continue to be made.

Interpolated Calibrations are only **slightly less accurate** than a calibration performed at the measurement settings. Learn more about the relative accuracy of FieldFox calibrations on page 61.

When a calibration that you performed is being interpolated, an asterisk is added to the Cal annotation. For example: **Cal ON U*** is shown on the screen when the current Response or Mechanical cal is being interpolated. An ***** is never added to a CalRdy.

Cal ON ? – Questionable Accuracy

When the Output Power, Interference Rejection, or IF BW (NA Mode ONLY) setting is changed AFTER performing a calibration, a question mark is added to the Cal annotation. For example: **Cal ON Q?** is shown on the screen when the current QuickCal is being interpolated. An **?** is never added to CalRdy.

The resulting measurement accuracy depends on how much the setting has changed. For highest accuracy, recalibrate using the new settings.

Compatible Mode Calibrations

The FieldFox can have only ONE calibration present for all modes (except CalReady). Calibrating in one mode will overwrite calibrations for other modes.

Because NA, CAT, and VVM modes are very similar, a calibration that is performed in one mode can also be applied in the other modes.

To apply a Cal, select a mode that is different from the mode in which the Cal was performed. Then press **Cal 5** then **Cal ON**.

Save the Calibration

After performing any type of calibration, you can save the FieldFox settings along with the calibration into a STATE (*.sta) file. These settings and calibration can then be recalled as necessary. To learn how, see **Saving and Recalling Files** on page 88.

CalReady Properties

There are several factory CalReady calibrations on every FieldFox. These can be selected based on the type of DUT that you measure most often, and the compromise that you prefer to make between measurement speed versus measurement accuracy. Remember, CalReady was performed at the test ports. Therefore, a CalReady calibration is most accurate when the DUT is connected to the test ports. Learn more about CalReady on page 52.

This setting does NOT survive Preset or Power ON/OFF.

Press **Cal 5** then **More**

Then choose from: **CalRdy 2-Port Enh Respon**

- **Full 2-Port Cal** – Corrects all four S-parameters. Requires a forward and reverse sweep, which causes slower trace measurements. Learn why on page 57.
- **Enhanced Response** (default) – Corrects forward (S21 and S11) and reverse (S12 and S22) measurements separately. Therefore, when measurements in only one direction are required, this choice provides faster trace measurements than a full 2-port cal.
 - Then choose from the following:
 - **Non-Reciprocal** (default) An amplifier is a Non-Reciprocal device because it has gain in the forward direction, and very high loss (isolation) in the reverse direction. This choice provides the best correction for non-reciprocal devices, and reasonable correction for reciprocal devices.
 - **Reciprocal** A reciprocal DUT is a device in which the insertion loss through the device is similar in both the forward (S21) and reverse (S12) directions. A cable is a reciprocal device. This choice provides the best correction for reciprocal devices. However, S11 measurements on non-reciprocal devices will appear to have more return loss than the non-reciprocal choice.

To find the best choice for your DUT:

- Press **Preset** then **Preset**.
- Select the appropriate S-Parameter and other settings (frequency range, resolution, and so forth).
- Press **Trace 6** then **Math and Memory** then **Data->Mem**.
- Press **Data & Memory**.
- Press **Cal 5** then **More**
- Select a CalReady Cal to compare with the current setting.
- Press **Esc** to exit the cal menu.
- View the differences in the two traces.

Verifying Calibration and Jumper Cable Integrity

After calibrating, it is important to verify that the calibration is good. When using a jumper cable, also verify that the cable is of high quality.

Verify a Calibration

- Connect a LOAD standard at the calibration reference plane (where calibration standards were connected). This may be at the end of the jumper cable or at FieldFox **PORT 1** connector.
- In CAT Mode, select **Return Loss**.
- In NA Mode, select **S11** with Log Mag format.
- Observe the trace on the FieldFox screen:
 - Lower than 35 dB indicates a GOOD calibration.
 - Higher than 30 dB indicates that you should recalibrate.

Verifying Phase Accuracy

- Connect a LOAD standard at the calibration reference plane (where calibration standards were connected).
- In NA Mode, select a S11 Reflection with Polar or Smith Chart format.
- Because all LOAD standards have delay, you should see a small amount of phase rotation as a function of frequency. In general, the measurement result should agree with the characteristics of the calibration standard.

Test the Jumper Cable

With the LOAD standard still connected, move the jumper cable while observing the trace.

- If the measurement trace is relatively stable, the jumper cable is of good quality.
- If you observe significant movement in the peaks of the measurement trace when moving the cable (>5 dB), the jumper cable may need to be replaced.

Calibration Method Summary

- **Mechanical Full 2-port Cal** is ALWAYS the most accurate Cal method. The quality of a Mechanical Cal is completely dependent on the quality of the OPEN, SHORT, LOAD standards and the quality of the standard connections. Use the correct high quality standards to ensure the most accurate calibration.
- **QuickCal** (Opt 122) QuickCal should be performed when good accuracy is required while using a jumper cable or adapter.
 - During QuickCal, do NOT 'Skip Load' when measuring a DUT with good match (Return Loss better than 15 dB).
- **CalReady** is accurate ONLY when the DUT is connected at the test ports and most accurate at room temperature.
- **For highest accuracy**, a new QuickCal or Mechanical Cal should be performed:
 - When the temperature changes more than about 10°F (5°C)
 - When the connection to the DUT requires a different jumper cable or adapters.
 - When any of the following measurement settings change: Frequency Range, Power Level, IF BW, and Resolution.

Power Meter Mode

Power Meter measurements, available with Option 302, are made with Agilent U2000 Series USB power sensors. Power readings are displayed on the FieldFox screen.

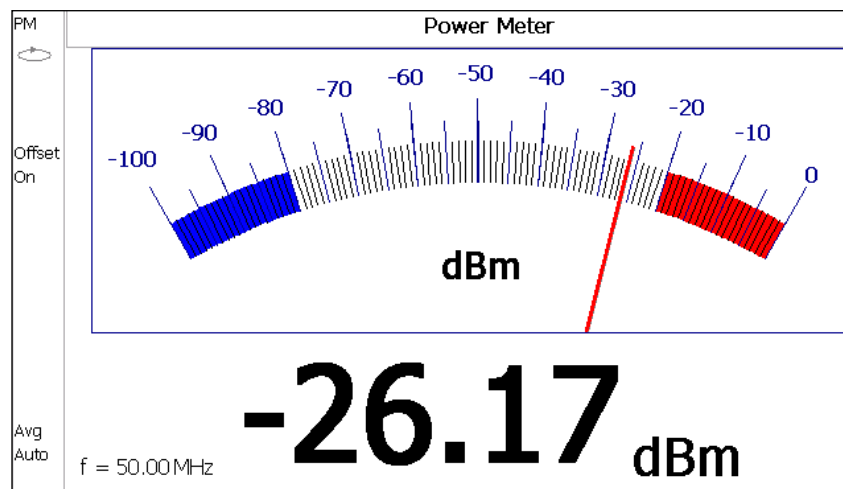

In this Chapter

Supported Power Sensors	62
How to Connect the Power Sensor	63
Zeroing.....	63
Set Frequency.....	64
Set Scale	64
Set Relative and Offset Power	65
Set Display Units	65
Set Averaging.....	66
Single/Continuous	66
Set Limits	67

Supported Power Sensors

Power Meter measurements are made using any of the **Agilent U2000 Series USB Power Sensors**.

NOTE The FieldFox does NOT support the following U2000 Series features: External Triggering (Time Gated Burst Power Measurement), Power Sweep Operation, and Frequency Sweep Operation.

- CAUTION** Please observe the damage level of your U2000 Series Power Sensor. Typical damage levels of the U2000 Series Power Sensor are:
- +25 dBm (320 mW) average
 - +33 dBm peak (2 W) <10 μ s
 - +5V

How to Connect the Power Sensor

Connect your U2000 Series Power Sensor to one of the USB ports.

NOTE Use an attenuator between the DUT and the power sensor when measuring power levels that are higher than +20 dBm. The attenuator value can be subtracted from the measurement using the Offset feature, discussed on page 65.

A sequence of status lights are displayed on the base of the power sensor.

- **Green blinking** light indicates the power sensor is communicating or self-tests are being performed. Because the FieldFox is usually communicating with the power sensor when it is connected, this is the normal mode of operation.
- **Amber light** indicates Internal Zeroing is being performed.
- **Red light** indicates an error has occurred with the power sensor. Refer to power sensor documentation.
- **No light** indicates the FieldFox is not communicating with the power sensor. This is the case when NOT in Power Meter Mode.

Power Meter Settings

Select Power Meter Mode before making any setting in this section.

How to select Power Meter Mode

- Press **Mode**.
- Then **Power Meter**.

Zeroing

The Agilent USB Power Sensors perform Internal Zeroing automatically. Because the U2000 series power sensors have an internal switch, Internal Zeroing does NOT require that the power source be turned OFF.

For highest measurement accuracy, when measuring power levels below -30 dBm, External Zeroing should be performed.

During External Zeroing, the power source MUST be turned OFF or the power sensor disconnected from the power source (device under test). Power is OFF when power sensor measurements are below -60 dBm. When power higher than this is detected at the sensor, a warning message is shown on the FieldFox and External Zeroing will not proceed.

How to perform External Zeroing

- Press **Cal 5**.
- Then **External Zero**.

While either Internal or External Zeroing is being performed, “**Zeroing...**” is shown on the FieldFox screen. While this message is present, do NOT make any changes to the FieldFox.

In addition, once External Zeroing has started, the power source must be OFF for the entire time that the Zeroing message is present. Otherwise, the calibration will be compromised but NO warning is shown.

Frequency

A table of correction factors versus frequency is stored within the Agilent U2000 Series Power Sensors. The frequency of the power to be measured is entered in the FieldFox so that the appropriate correction factor can be used.

The frequency of the power measurement is NOT limited by the frequency range of the FieldFox, but the frequency range of the power sensor, which can be much wider.

How to enter frequency of the Power Measurement

- Press **Freq/Dist** or **Meas Setup 4**.
- Then **Frequency**.
- Then type a value using the numeric keypad. The default frequency is 50 MHz.
- Then press a multiplier key. Learn about multiplier abbreviations on page 18.

The current frequency is shown on the FieldFox screen.

Scale

The scale of the Power Meter display can be set manually or automatically. The major and minor ticks are set automatically and can NOT be changed. Although the scale settings are limited, you can view measurements beyond these settings by performing Autoscale.

How to Scale the Power Meter display

Manually:

- Press **Scale / Amptd**.
- Then choose from the following:
 - **Scale Min** Sets the low power level of the power meter display. Type a number and select the units or press **Enter**. This value is limited to -100 dBm.
 - **Scale Max** Sets the high power level of the power meter display. Type a number and select the units or press **Enter**. This value is limited to 100 dBm.

Autoscale:

Using Autoscale, the current reading is used for the center of the scale, and Min and Max values are set accordingly.

- Press **Scale / Amptd**.

- Then **More**.
- Then **Autoscale**.

Relative and Offset Power Measurements

Power measurements can be made that are relative to another reading or that are offset by a fixed value.

- Use Relative to measure the difference between power levels.
- Use Offset to account for components or a long length of cable that is used before the power sensor. For example, if using a 10 dB attenuator to protect the FieldFox, enter an Offset Value of 10 to read the power as it would appear without attenuation. If using a 10 dB amplifier, enter an Offset Value of -10 to read the power as it would appear without amplification.

How to set Relative and Offset Power Measurements

- Press **Scale / Amptd**.
- Then choose from the following:
 - **Relative On Off** When switched to ON, the FieldFox measures and stores the current power level. Subsequent power measurements display a power level which is relative to the stored value. When relative is ON, the units change from dBm to dB or from Watts to %.
 - **Offset On Off** Toggles ON and OFF the displayed power level using the Offset value.
 - **Offset Val** Value by which the power meter display is offset. A positive value compensates for a component with loss. A negative value compensates for a component with gain. Offset values are limited to +/- 100 dB.

Display Units

Sets the Power Meter display to dBm or Watts. When making relative power measurements, these change to dB and %.

How to set Power Meter display units

- Press **Meas Setup 4** or **Scale / Amptd**.
- Then **Unit**.
- Then choose from the following:
 - **dBm (dB)** Sets Power Meter display to dBm or dB.
 - **Watt (%)** Sets Power Meter display to Watts or %.

Resolution

Sets the number of digits to display after the decimal point on the digital power meter display.

How to set Resolution

- Press **Scale / Amptd**.
- Then **More**.
- Then choose from **0, 1, 2** , or **3**.

Averaging

Power Meter Averaging is used to improve measurement accuracy in low power or noisy power situations. Increased averaging improves measurement accuracy, but also reduces measurement speed.

How to set Power Meter Averaging

- Press **BW 2** or **Meas Setup 4**.
- Then choose from the following:
 - **Averaging Auto Man Off**
 - **Auto** Allows the USB Power Sensor to use its Auto Averaging settings. See the USB Power Sensor documentation for details.
 - **Man** Manually enter an averaging count by setting **Num Averages**.
 - **OFF** Performs NO averaging.
 - **Num Averages** Sets the number of Power Meter readings to be averaged before a valid reading is displayed. When a number is entered, **Averaging** is automatically set to Man

Single or Continuous Measure

This setting determines whether the FieldFox measures continuously or only once each time the **Single** button is pressed. Use **Single** to conserve battery power or to allow you to save or analyze a specific measurement.

This setting can be changed at any time without affecting calibration accuracy.

How to set Single or Continuous

- Press **Sweep 3**.
- Then choose one of the following:
 - **Single** Automatically sets Continuous OFF and causes FieldFox to make ONE measurement, then hold for the next Single key press. When a data trace is displayed, the entire trace is measured, then holds. The **Hold** annotation changes to an arrow --> while the measurement occurs.
 - **Continuous** Makes continuous measurements. This is the typical setting when battery power is not critical.

You can also use **Run / Hold +/-** to toggle between Single and Continuous.

Limits

In Power Meter Mode, Minimum and Maximum limits set a visible range of acceptable readings between these two values. Readings that are below the minimum or above the maximum are clearly visible on the power meter display.

How to set Limits

- Press **Limit 8**.
- Then choose from the following:
 - **Min Limit On Off** Toggles the display of the Minimum limit ON and OFF.
 - **Min Limit Value** Sets the Minimum limit power value. Power reading lower than this will exceed the limit.
 - **Max Limit On Off** Toggles the display of the Maximum limit ON and OFF.
 - **Max Limit Value** Sets the Maximum limit power value. Power reading higher than this will exceed the limit.

VVM (Vector Voltmeter) Mode

VVM Mode (Option 308) measures the electrical length of cables and other devices. The 1-Port Cable Trimming and 2-Port Transmission measurement displays the electrical length in both Magnitude and Phase.

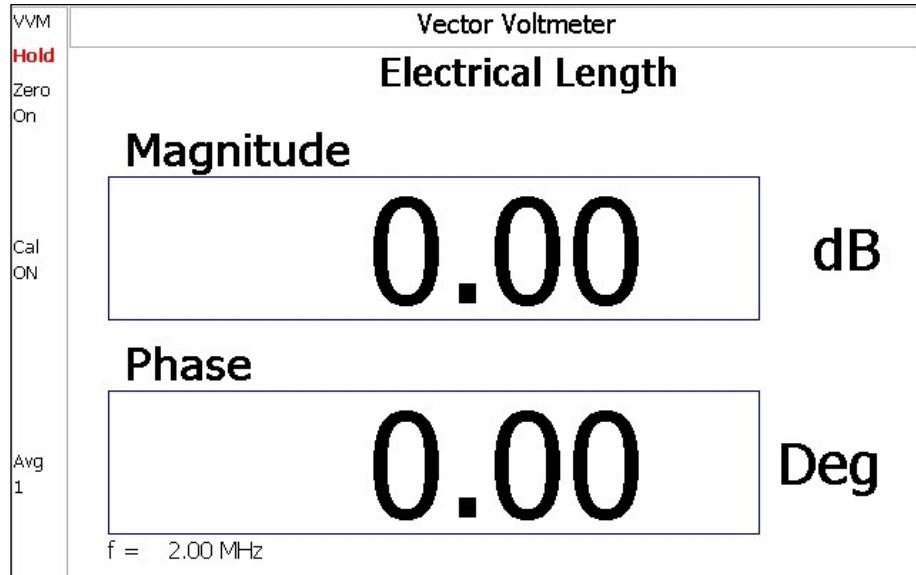

Display for the 1-Port Cable Trimming measurement

In this Chapter

Overview	69
VVM Calibration.....	70
Measurement Selection.....	70
Frequency Selection.....	70
Display Resolution.....	71
IF Bandwidth.....	71
Output Power	71
Averaging	72
Single/Continuous	72
Zeroing.....	73

Procedures

1-Port Cable Trimming Measurement	73
2-Port Transmission Measurement.....	74

Overview

In the FieldFox, both 1-port and 2-port measurement types use a different configuration setup from the HP/Agilent 8508A Vector Voltmeter.

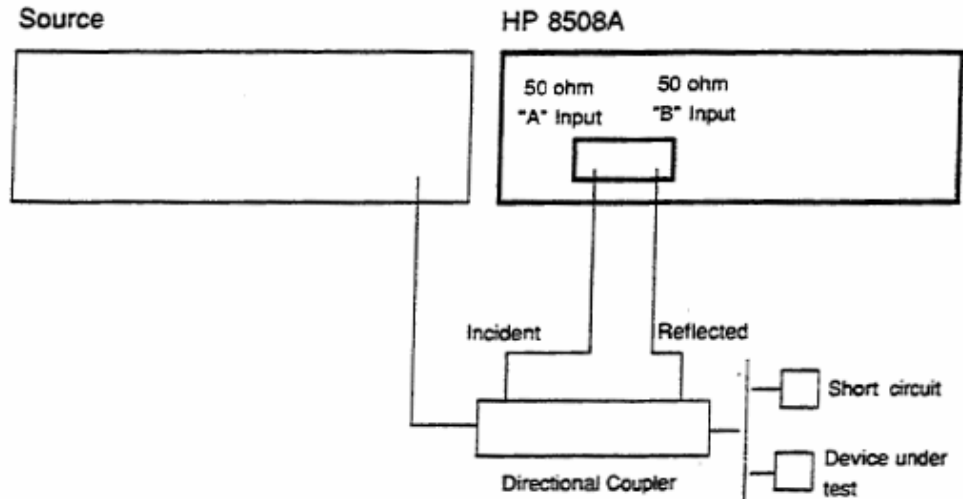

Typical 8508A measurement configuration –as shown in the 8508A manual.

The above block diagram requires an external source and directional coupler to measure the electrical length of a DUT or cable to be trimmed. Separate paths are used to measure the Incident signal (A) and Reflected signal (B). To measure the ratio of the Reflected/Incident signals, you were required to select B/A for both the Magnitude and Phase display.

In the following FieldFox block diagram, the source and directional coupler are inside the instrument. This allows you to connect the DUT to **ONLY** the FieldFox **PORT 1** with **NO** external instruments, in order to make 1-Port Cable Trimming measurements.

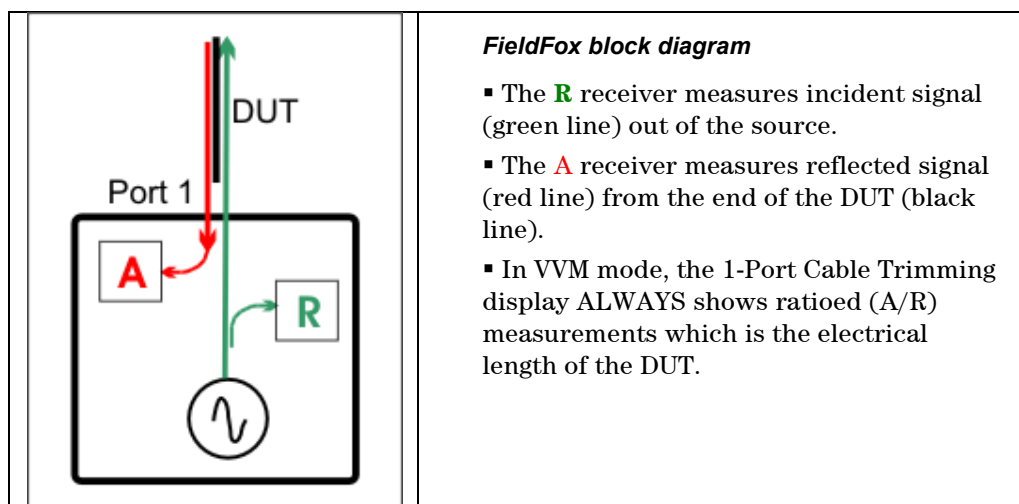

VVM Calibration

Calibration of a VVM Mode measurement can be accomplished using one of several methods depending on the desired level of accuracy.

- The simplest method is to use CalReady which is accurate at the test port connectors. CalReady does not correct for the loss or delay of jumper cables or adapters that may be used to connect the DUT to the FieldFox. Learn more about CalReady on page 52.
- The next simplest method is to perform a Zeroing. Learn more on page 73.
- When using jumper cables or adapters to connect the DUT to the FieldFox, the most accurate method is to perform a QuickCal or Mechanical Cal. Learn more on page 51. Press **Zero OFF** before calibrating.

VVM Mode Settings

Select VVM Mode before making any setting in this section.

NOTE In VVM Mode, the power level out of the internal FieldFox source is always approximately +6 dBm and can NOT be changed.

How to select VVM Mode

- Press **Mode**
- Then **VVM**

Measurement Selection

How to select a VVM Measurement

- Press **Measure 1**
 - Then choose from the following:
 - **1-Port Cable Trimming** 1-port reflection measurement. Learn how to make this measurement on page 73.
 - **2-Port Transmission** 2-port transmission measurement. Learn how to make this measurement on page 74.
- B/A** and **A/B** 2-port ratioed receiver measurements using external sources. Learn more on page 75.

Frequency Selection

VVM measurements are made at a single CW frequency.

How to set Frequency

- Press **Freq/Dist**
- Then **Frequency**
- Enter a value using the numeric keypad, the **▲▼** arrows, or the rotary knob.

- After using the **▲▼** arrows or the rotary knob, press **Enter**. The increment setting of the arrows is based on the current span and can NOT be changed in VVM Mode.
- After using the keypad, select a multiplier key. Learn about multiplier abbreviations on page 18.

Display Resolution

You can display either one digit or two digits after the decimal point for both magnitude and phase readings.

This setting survives a Preset and Mode Preset.

How to set Resolution

- Press **Scale/Amptd**
- Then **Resolution**
- Then choose:
 - **1** 0.0 (default)
 - **2** 0.00

IF Bandwidth

Reducing the IF receiver bandwidth reduces the effect of random noise on a measurement. However, narrower IF bandwidths cause longer measurement times.

For highest accuracy, set IF BW before calibrating.

How to set IF BW

- Press **BW 2**
- Then **IF BW**
- Then choose from the following: **300 Hz | 1 kHz | 3 kHz | 10 kHz | 30 kHz**

Output Power

Set the power level out of the FieldFox to either High power or Low power. Generally, the high power level (default setting) is more accurate because the receivers are measuring farther from the noise floor. However, some devices are sensitive to high power levels. Use the Low power setting when measuring amplifiers.

NOTE To help prevent damage to your DUT, when Output Power is changed in CAT or NA Mode, it is changed to the same value in VVM Mode.

How to set Output Power

- Press **Meas Setup 4** then **More**
- Then **Output Power High Low** The underlined value is the current setting.
 - **High** Sets output power to approximately +5 dBm.

- **Low** Sets output power to approximately -25 dBm.

Averaging

Averaging helps to reduce the effects of random noise on a measurement. The FieldFox computes the displayed value over several consecutive readings. Average count determines the number of readings to average. The higher the average count, the greater the amount of noise reduction.

An average counter is shown in the left edge of the screen as **Avg N**. This shows the number of previous readings that have been averaged together. When the counter reaches the specified count, then a 'running average' of the last **N** readings is displayed.

Average count = 1 means there is NO averaging.

This setting can be changed at any time without affecting calibration accuracy.

How to set Averaging

- Press **Meas Setup 4**
- Then **More**
- Then **Average N** where **N** is the current count setting.
- Enter a value using the numeric keypad. Enter 1 for NO averaging.
- Press **Enter**.

To restart the averaging process, press **Meas Setup 4**, then **More**, then **Restart**

Single or Continuous Measure

This setting determines whether the FieldFox measures continuously or only once each time the **Single** button is pressed. Use **Single** to conserve battery power or to allow you to save or analyze a specific measurement.

This setting can be changed at any time without affecting calibration accuracy.

How to set Single or Continuous

- Press **Sweep 3**.
- Then choose one of the following:
 - **Single** Automatically sets Continuous OFF and causes the FieldFox to make ONE measurement, then hold for the next **Single** key press. When a data trace is displayed, the entire trace is measured, then holds. The **Hold** annotation changes to an arrow --> while the measurement occurs.
 - **Continuous** Makes continuous measurements. This is the typical setting when battery power is not critical.
- You can also use **Run / Hold +/-** to toggle between Single and Continuous.

Zeroing

Zeroing, also known as Normalization, or Data/Memory, simply “Zeroes” the Magnitude and Phase display when **Zero** is pressed. All subsequent measurements are relative to the measurement that was made when Zero was pressed.

- When performing a 1-Port Cable Trimming operation, a reference cable is connected and measured. Then Zero is pressed, and subsequent cables are measured and trimmed to match electrical length of the reference cable.
- For 2-port measurements, Zero is typically pressed when a THRU connection is made in place of a DUT. Learn more on page 74.

Press **Zero OFF** before performing a QuickCal or Mechanical Cal.

How to select Zeroing

- Press **Meas Setup 4**
- Then **Zero**

Press **Zero OFF** to turn zeroing off.

1-Port Cable Trimming Measurements

A 1-Port Cable Trimming measurement is used in a cable fabrication procedure to validate proper electrical length. Read the **Overview** section in this chapter to learn more about this measurement and the calibration process.

How to make a 1-Port Cable Trimming Measurement

1. Press **Mode** then **VVM** then **1-Port Cable Trimming**.
2. Press **Freq/Dist** and enter the frequency for the measurement.
3. Press **Meas Setup 4** then **Zero OFF**.
4. Calibrate the FieldFox: (Learn more about VVM calibration on page 70.)
 - If using an adapter to connect the cables to the FieldFox, press **Cal 5** then select either **QuickCal** or **Mechanical Cal**. Follow the FieldFox calibration prompts. During calibration, the measurement (S-parameter) is referred to as S11.
 - If connecting the cables directly to the FieldFox test port, CalReady is very accurate.
5. To ensure that the FieldFox is properly calibrated, perform the following **optional Measurement Verification** procedure.

NOTE This measurement verification procedure is suitable for low frequency measurements. However, for high frequency measurements, a more sophisticated procedure is required.

- a. Connect a short standard to the **PORT 1** calibration plane (the location where the calibration was performed).
- b. Press **Meas Setup 4** and press **Zero**.
- c. Connect the open standard to the FieldFox **PORT 1** connector.
- d. Confirm that magnitude measurement is less than -0.1 dB and that the phase value reads 180 degrees.

6. Attach the shortest cable to the FieldFox **PORT 1** connector. This cable is the reference cable. Leave the end of the reference cable open (unterminated).
7. Press **Meas Setup 4** then press **Zero**.
8. Remove the reference cable from the FieldFox **PORT 1** connector.
9. Connect an unterminated, longer cable to the FieldFox **PORT 1** connector.
10. Observe the displayed phase difference between the reference cable and the attached cable.
11. Carefully trim the cable until the phase shift reads zero. **The attached cable's electrical length is now matched to the reference cable.**
12. Repeat steps 9 through 11 for the remaining cables to be trimmed.

2-Port Transmission Measurements

A 2-Port Transmission measurement is used for measuring electrical length, insertion loss, gain, or isolation of a DUT at a single CW frequency. The FieldFox signal source is transmitted out the port 1 connector, through the DUT, and into the port 2 connector. In the following image, the gain of an amplifier is being measured.

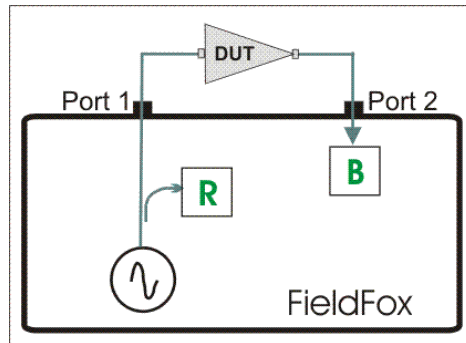

2-Port Transmission measurement of an amplifier

How to make a 2-Port Transmission Measurement

NOTE In VVM Mode, the power level out of the internal FieldFox source is always approximately +6 dBm and can NOT be changed. This may be too much input power to an amplifier.

1. Press **Mode** then **VVM** then **2-Port Transmission**.
2. Press **Freq/Dist** and enter the measurement frequency.
3. Calibrate the FieldFox using one of the methods described on page 70. Before performing a QuickCal or Mechanical Cal, press **Meas Setup 4** then **Zero OFF**.
4. Connect the DUT.

Notes:

- The magnitude value is the gain (positive value) or the loss (negative value) of the DUT.
- The phase value is the difference in phase (in degrees) between the DUT input and output.
- To measure isolation of the amplifier, reverse the connection to the amplifier (**PORT 1** to the amplifier output).

A/B and B/A Measurements

These measurements allow you to use the FieldFox A and B receivers, along with an external source, to make ratioed measurements. You would do this if your measurement requires the use of an external source.

The following image shows a typical configuration for a **B/A** magnitude and phase measurement of a 2-port DUT. This DUT can be an antenna / probe setup. Using network analyzer terms, the image shows the A receiver as the reference receiver which measures the signal that is applied to the DUT. The B receiver is the test port receiver which measures the DUT response.

For added measurement stability, both the external source and FieldFox should share the 10 MHz frequency reference. Connect a cable between the external source 10 MHz reference output and the FieldFox 'Ext. Ref.' input. On the FieldFox, set **Ext. Ref** to **Ext**. Learn how on page 103.

Increase the IFBW setting to enhance the ability of the FieldFox to lock onto the external source and improve measurement stability.

To calibrate for this measurement, replace the DUT with a THRU connection, preferably by connecting together two Power Splitters (shown in green below). For low frequency measurements, TEEs can be used.

Then press **Zero**.

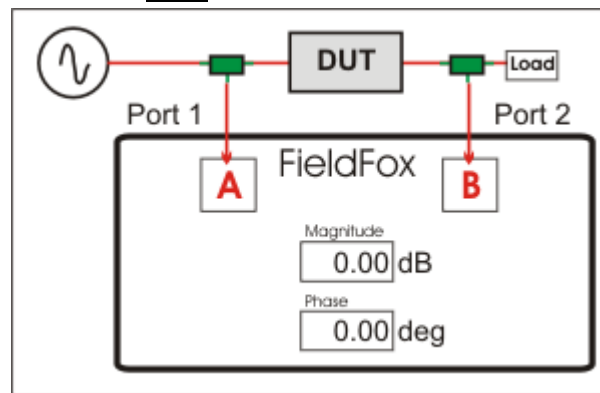

B/A Transmission measurement with external source

Data Analysis Features

The following features can be used to analyze NA and CAT mode measurement results.

In this Chapter

All about Markers	76
About Delta Markers	77
Marker Table	78
Coupled Markers	78
Marker Trace	79
Marker Format	80
Searching with Markers	80
What Is a 'Peak'	83
Marker Functions	84
All about Limit Lines	84
How to Save and Recall Limits	86
All about Trace Math	86
About Math Operations	87

All about Markers

Markers move along the X-axis range of the measurement trace to provide a numerical readout of each measured data point. Markers also allow you to search for specific Y-axis values.

A trace can contain up to six markers.

The marker readout on the FieldFox shows X and Y-axis information for the active marker ONLY.

A Marker Table can be displayed that allows you to simultaneously view X and Y-axis information for all markers.

Markers can be used in **CAT**, **SA**, and **NA** Modes.

How to create Markers

- Press **Marker**.
- Then **Markers 1...6** to select a marker to activate.
- Then **Normal** to activate that marker. A marker is created on the trace in the middle of the X-axis. That marker is now **active**.
- Then move the marker using the rotary knob, the **▲▼** arrows, or by entering an X-axis position with the number keys.
- Then press **Enter**.

How to move a Marker after it is created

- Press **Marker**.

- Then **Markers 1..6** repeatedly until the marker of interest is selected. The OFF, Normal, or Delta softkey is black to indicate the current setting of each marker.
- Then move the marker as when it was first created.
- Markers can also be moved using one of the marker search functions. Learn more on page 79.

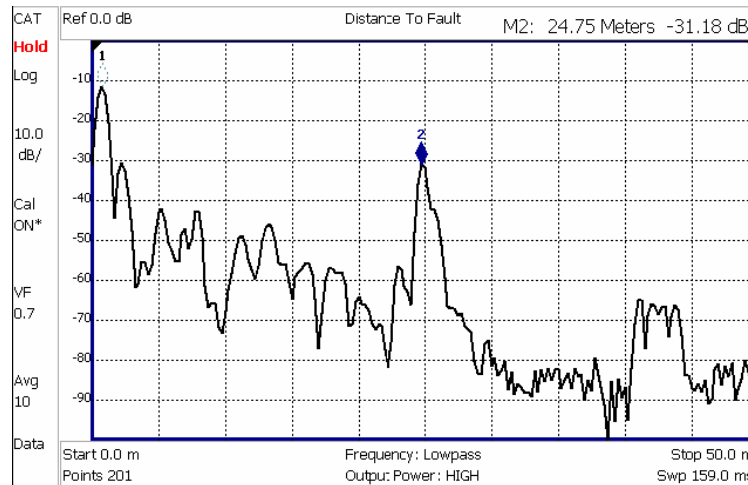

Marker 2 is active, marker 1 is NOT active.

About Delta Markers

A delta marker provides X-and Y-axis readout information that is **relative** to a 'reference' marker.

A delta marker is created with a ▲ (delta symbol) to distinguish it from the reference marker.

All six markers can be delta/reference marker pairs.

Peak search functions can be performed using delta markers. The delta marker moves to the peak;; the reference marker does NOT move.

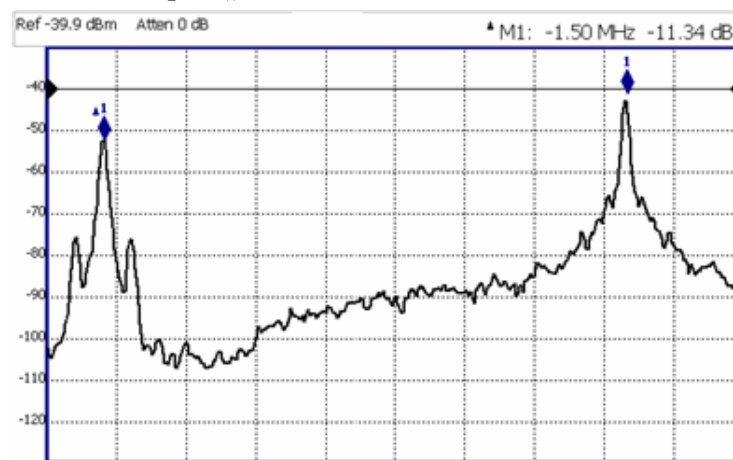

A Delta marker and its associated reference marker. The marker readout shows the difference between the two markers in frequency and amplitude.

How to Create a Delta Marker

- Create a **Normal** marker and move it to the reference position.
- Press **Delta**. The marker becomes the reference marker. It becomes fixed at its X-Axis position.
- Move the Delta marker by entering a value with the numeric keypad, by using the **▲▼** arrows, or using the rotary knob.
- Press **Enter** when finished.

How to move the Reference marker

- Press **Delta** to turn the Delta marker OFF.
- Move the marker to the new position.
- Then press **Delta** again, to turn the Delta marker back ON.

Marker Table

The Marker Table, displayed at the bottom of the FieldFox screen, is used to simultaneously display information for ALL markers. The marker table “squeezes” the graticule area when activated.

With NA mode Multi-trace configurations, the marker table appears for ALL traces, although some windows show only markers 1, 2, and 3. Learn more about Multi-trace configurations on page 21.

How to display the Marker table

- Press **Marker**.
- Then **Marker Table On Off**.

Coupled Markers

Coupled Markers, available in NA mode only, allows you to simultaneously create and move markers that have the same number for all traces. For example, when marker 2 is created on a trace, a marker 2 is created for ALL traces. When any marker 2 is moved, they all move together to the same X-axis position.

- Coupled markers are allowed only in NA mode and are relevant only in multi-trace configurations.
- You can have markers that are coupled, and others that are uncoupled.
- Peak functions move the marker to the peak on the **active trace**, while all other markers move to the same X-axis position.

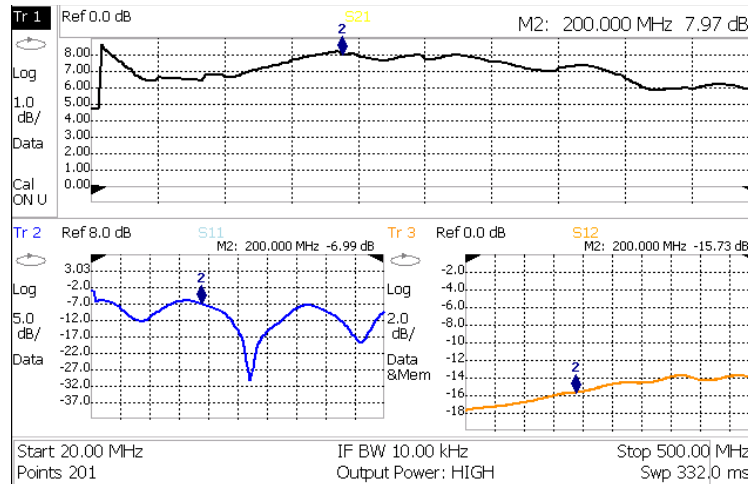

Coupled Markers ON allows Marker 2 to be moved on ALL traces at the same time.

How to create Uncoupled Markers

NOTE Markers are coupled by default.

To create markers that are NOT coupled (move independently on each trace):

- Press **Marker**
- Then **More**
- Then **Coupled Markers OFF**

Marker Trace

Both CAT and NA Modes can display a data trace and a memory trace. By default, markers are assigned to the data trace. However, you can move a marker between the data and memory trace. The marker moves to the same X-axis location on the specified trace.

When Coupled Markers is ON, this setting applies to the active marker for ALL traces that are coupled. Otherwise, this setting applies to the active marker on only the active trace.

How to move a marker between data and memory traces

- Create a data and memory trace that will host the marker. Learn how on page 86.
- Press **Marker** and **Enter** to create a marker.
- Then **More**
- Then select the marker to move using **Marker 1,2,3,4,5,6**.
- Then toggle **Marker Trace Auto Data Mem**.
 - **Auto** - Marker resides on data trace when it is visible. Marker resides on memory trace when only IT is visible.
 - **Data** - Marker resides on data trace, even when not visible.
 - **Mem** - Marker resides on memory trace, even when not visible. If a memory trace is not stored, the marker moves to 0.0 dB at the same X-axis position

Marker Format

The Marker Format setting is available in NA Mode in either Smith Chart or Polar display format. Choose the format of the marker readout (upper right corner of screen). Learn how to set display format on page 23.

How to choose marker format

- Press **Marker**
- Then **More**
- Then **Marker Format**
- Then choose from the following:

- **Mag & Phase** Magnitude and Phase M1: 2911.030 MHz 0.975, 115°
- **R + jX** Complex impedance format M1: 2911.030 MHz 0.9 + j32.1 Ω
1.756 nH

Searching with Markers

Marker Searches are used to move markers to locations on the trace which exhibit the characteristics of the search criteria. Learn ‘What is a Peak’ on page 83.

How to Search with Markers

The following menu structure applies to NA Mode. For keystroke information for CAT mode, see Hardkey/Softkey Menus on page 115.

- Activate the marker to move. Activate the marker to be used for the search (NOT necessary with Bandwidth search.)
- Then press **Mrk ->/Tools**.
- Then **Marker Search**
- Then choose from the following:
 - **Tracking ON OFF** (NA Mode ONLY)
 - **ON** causes the active marker to search for the specified criteria with each new sweep. Search criteria can include: Target, Bandwidth, Peak, Min. The searches begin with the first sweep after Tracking is turned ON based on the current search type. The stimulus setting for a marker can NOT be changed manually. **Trk** appears next to the marker number.
 - **OFF** causes a new marker search only when the search feature is re-executed.
 - **Peak** Moves the active marker to the HIGHEST amplitude data point of the trace. The Peak Excursion value is ignored.
 - **Min** (Not available in DTF) Moves the active marker to the LOWEST amplitude data point of the trace.

- **Target** (NA Mode ONLY) Enter the Target value. The marker moves to the first occurrence of the Target value to the right of its current position. The FieldFox interpolates between measured data points to find the exact Target value to two decimal points. The interpolated X-axis value is displayed in the marker readout or marker table. Subsequent presses of the Target softkey cause the marker to move to the right to find the next occurrence of the Target value. When the marker reaches the end of the stimulus range, it "wraps around" and continues the search from the beginning of the stimulus range.
- **Bandwidth ON OFF** (NA Mode ONLY) Use to quickly toggle BW Markers ON and OFF. When OFF, the marker table appears showing the X and Y-axis positions of all enabled markers.
- **Bandwidth** (NA Mode ONLY) Specify the level in dB from the peak or valley where bandwidth is measured.
 - **Negative** numbers search for a **Peak** bandpass, such as a filter S21 response.
 - Either of the following TWO methods can be used to search for a **Valley** or Notch filter, such as the S11 response of a bandpass filter.
 - **Negative** values search down from the TOP (MAX) of the response.
 - **Positive** values search up from the BOTTOM (MIN) of the notch.
 - If you first enter Negative, then Positive values, it may be necessary to press **Marker**, then **More**, then **Markers All Off**.

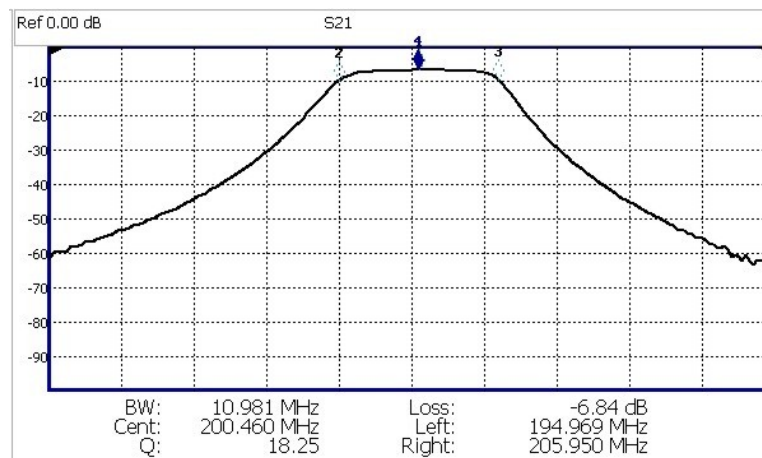

**S21 of a filter with BW Markers and associated readout values.
The search criteria is -3 dB.**

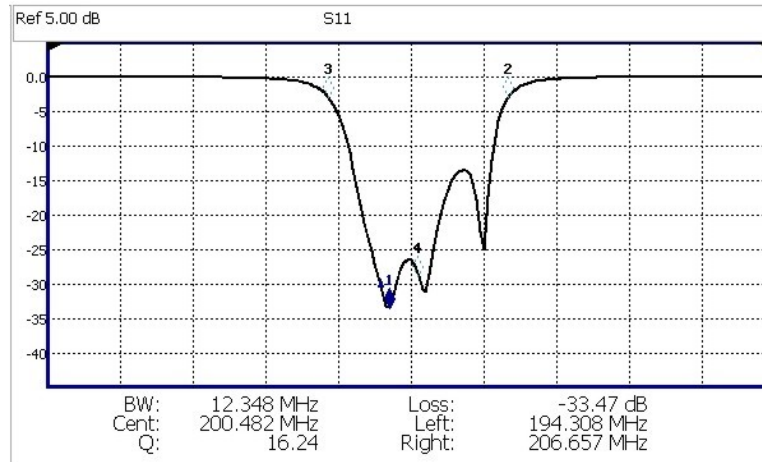

S11 of the same filter with same search criteria: -3 dB. The same values would result from a search criteria of approximately +30.4 dB.

Press **Enter** and four markers are automatically created to find the first negative or positive bandpass over the displayed frequency range.

Bandwidth Search can be used ONLY with Log Mag display format.

The following six values are displayed for Bandwidth Search:

- **BW:** Width of the filter. (marker 2 freq) **minus** (marker 3 freq).
 - **Center:** Marker 4 frequency. Mathematical midpoint between marker 2 and marker 3.
 - **Q:** Center Frequency / Bandwidth.
 - **Loss:** Marker 1 amplitude.
 - **Left:** Frequency of marker 2 or 3 (to left of marker 1).
 - **Right:** Frequency of marker 2 or 3 (to right of marker 1).
- Press **Back** to return to the previous menu.
 - Press **Peak Search** then choose from the following:
 - **Peak** Moves the active marker to the HIGHEST amplitude data point of the trace. Peak Excursion value is ignored.
 - **Next Peak** Moves the active marker to the next highest amplitude peak from where it currently resides.
 - **Peak Left** Moves the active marker to the next data point to the left that meets the 'Peak' criteria. When no data points to the left meet the 'Peak' criteria, the marker does not move.
 - **Peak Right** Moves the active marker to the next data point to the right that meets the 'Peak' criteria. When no data points to the right meet the 'Peak' criteria, the marker does not move.
 - **More** then **Min Search** (Not available in DTF) Moves the active marker to the LOWEST amplitude data point of the trace.

The following applies to DTF Measurements ONLY:

- **More**.
- **Track Peaks ON OFF** When Track Peaks is ON, markers will find the new peak with every sweep. While in this Mode, the markers can NOT be turned OFF or moved.
- **Find 3 Peaks** Three markers are created and find the highest peaks (faults) on the trace.

What Is a 'Peak'

You define what the FieldFox considers a "peak" by setting the Peak **Threshold** and Peak **Excursion**.

These two peak criteria settings apply to markers 1 to 6 in the same mode, but are set individually for CAT and NA Modes.

These settings survive a FieldFox or Mode Preset. They are reset to the default values when the FieldFox power is shutdown.

NOTE Peak Threshold and Excursion are NOT available in DTF measurements. However, peaks below -50 dB will NOT be found and this can NOT be changed.

How to set Peak Criteria

- Press **Mrk ->/Tools**.
- Then **More**.
- Then select the following:
 - **Peak Threshold** Minimum amplitude (dB). To be considered valid, the peak must be **above** the threshold level. The valley on either side can be below the threshold level. Default = -190.
 - **Peak Excursion** The vertical distance (dB) between the peak and the valleys on both sides. To be considered a peak, data values must "fall off" from the peak on both sides by the excursion value. Default = 0.5 dB.

For example, the settings for the trace in the following image are:

- Threshold: -10 dB
- Excursion: 1 dB
- Scale = 1 dB / Division.

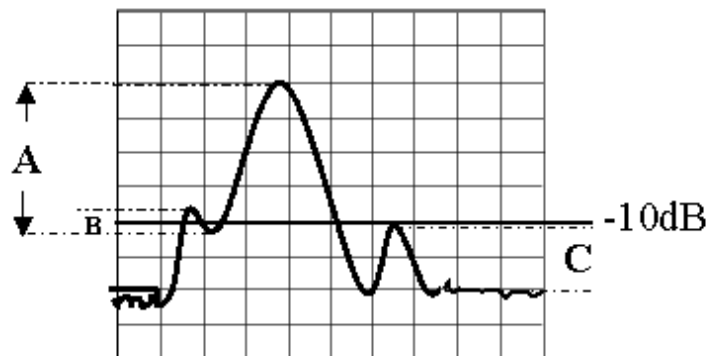

Peak A = **Valid Peak** (Above Threshold and Excursion Settings)

Peak B = Invalid Peak (Below 1 dB Excursion Setting)

Peak C = Invalid Peak (Below -10 dB Threshold Setting)

Marker Functions

Marker functions are used to change FieldFox frequency or distance settings to those of the active marker.

How to use Marker Functions

- Activate the marker to move.
- Then press **Mrk ->/Tools**.
- Then choose one of the following:
 - **Mrk -> Center** (Not available in DTF mode) The center frequency of the measurement becomes the value of the active marker. The frequency span is adjusted accordingly.
 - **More** then **Mkr -> Delay** (NA mode ONLY) The group delay value of the active marker becomes the electrical delay setting of the trace. Learn how to set group delay format on page 23. Learn more about electrical delay on page 25.

The following applies to DTF Measurements ONLY:

- **More** then:
 - **Marker=>Start Distance** The Start Distance of the measurement becomes the value of the active marker. Markers that would no longer appear on the screen are moved to the new Start Distance.
 - **Marker=>Stop Distance** The Stop Distance of the measurement becomes the value of the active marker. Markers that would no longer appear on the screen are moved to the new Stop Distance.

All about Limit Lines

Limit Lines are available in CAT Mode and NA Mode. Power Meter Mode uses different Limit settings. Learn more on page 67.

Limit Lines are visual representations on the FieldFox screen of the specified limits for a measurement. With this capability, you can easily compare measured data versus specifications. In addition, you can enable an audible beep and display **Pass or Fail** information for each measurement.

You can have up to **10 Limit Lines** for each measurement trace allowing you to test all aspects of your measurements.

With multi-trace configurations, Limit Lines are applied individually for each displayed trace. Learn more on page 21.

Limit Lines can be saved and recalled with an *.sta file. Learn more about *.sta files on page 88. They can also be saved and recalled independently from the Limit softkeys. Learn more on page 86.

Limit Lines and Limit testing are NOT allowed with **Smith Chart** or **Polar** display formats.

How to Create Limit Lines

- Press **Limit 8**.
- Then **Edit**.
- A Limit Line Table appears. Use **Left** and **Right** softkeys, and the **▲▼** arrows to create Limit Lines.
- **On** Press **Enter** to toggle the display of the limit line ON (X) and OFF (clear).
- **Type** Press **Enter** to toggle the line Upper or Lower. An **Upper** limit will FAIL any measured data point **ABOVE** the line. A **Lower** limit will FAIL any measured data point **BELOW** the line .

Each Limit Line is constructed by setting the X/Y-coordinates for both the beginning and end of line, as in the following image. The X-axis values for two lines can overlap.

- **Start Frequency/Distance** X-axis value for start of line.
- **Start Amplitude** Y-axis value for start of line.
- **Stop Frequency/Distance** X-axis value for stop of line.
- **Stop Amplitude** Y-axis value for stop of line.

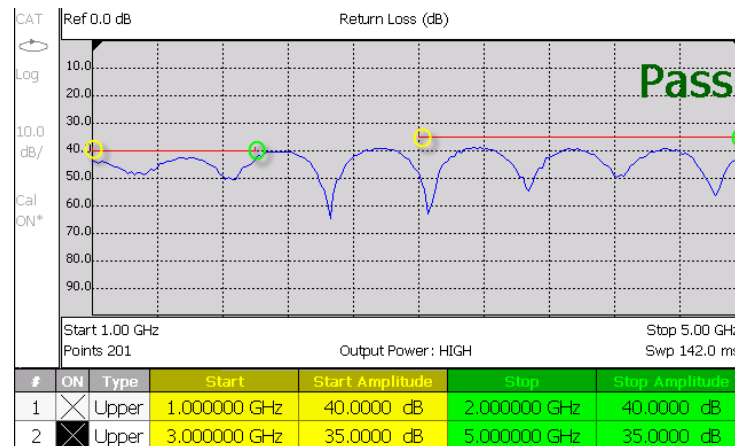

**Limit table with two Upper limit lines. Warning ON.
Yellow circles and shading shows Start of lines.
Green circles and shading shows Stop of lines.**

How to set Limit Options

- Press **Exit** if the Limit Table is visible.
- Then **Options**.
- Then choose from the following:
 - **Beep On Off** Audible beep sounds when each sweep fails.
 - **Warning On Off** Shows **Pass** or **Fail** indication on the display with each sweep. Data points that fail are highlighted.

How to Save and Recall Limits

In addition to saving and recalling Limit Lines with an *.sta file, Limit Lines can also be saved and then recalled independent of the current mode or measurement. Use this feature to recall and apply existing limit lines to measurements with different settings or even a different frequency range.

Limit Line files can be loaded into the FieldFox Data Link Software. Learn how in the help file that is included in the Data Link software.

How to Save and Recall Limits

- Press **Save/Recall** then **Select Device** to set the Device (Internal, micro SD card, or USB flash drive) to be used for the Save or Recall. Learn more on page 90.
- Then press **Limit**.
- Then choose from the following:
 - **Save Limits** After Limit Lines have been defined, this saves the line definition to a file on the specified device.
 - **Recall Limits** Recalls a Limit Line definition from the specified device.

All about Trace Math

Trace Math is available ONLY in **CAT** and **NA** Modes, but not in DTF measurements.

A trace is a series of measurement data points that are connected to form a line. This 'live' data trace is updated as data points are measured.

A memory trace is a live trace that has been stored in the FieldFox volatile memory. It then becomes static, meaning it is not updated with measurements. It can be displayed on the screen by itself, or with a data trace for comparison purposes.

- In NA mode, memory traces are the same color as data traces, but muted (duller).
- In CAT mode, the data trace is displayed in **yellow** and the memory trace is displayed in **blue**.

How to display data and memory traces

- Press **Trace 6**.
- Then **Data->Mem** to store the ACTIVE data trace into memory. A 'beep' sounds to confirm the data trace has been stored to memory. There is no display annotation that indicates that the memory trace has been stored.
 - Press **Data** to view only the data trace. **Data** is annotated in the left pane.
 - Press **Memory** to view only the memory trace. **Mem** is annotated in the left pane.
 - Press **Data & Memory** to view both the data trace and the stored memory trace. **Data&Mem** is annotated in the left pane.

How to perform Trace Math

Trace math is performed between a data trace and a memory trace. When one of the following math operations are selected, the data trace displays the current measurement with the selected trace math applied. The math operation symbol indicated below in [brackets] is displayed in the left pane.

- Press **Trace 6**.
- If not already stored, press **Data->Mem** to store the current data trace into memory.
- Then **Data Math**.
- Then choose one of the following:
 - **Data + Memory** [D+M] Current trace data **added to** memory data.
 - **Data – Memory** [D-M] Current trace data **subtracted from** memory data.
 - **Data / Memory** [D/M] Current trace data **divided by** memory data.
 - **Math Off** [Data] Displays trace data with NO math applied.

About Math Operations

Data / Memory and **Data - Memory** math operations are performed on complex linear data before it is formatted. Because data is often viewed in log format, it is not always clear which of the two math operations should be used. Remember: dividing linear data is the same as subtracting logarithmic data. The following illustrates, in general, when to use each operation.

Use **Data / Memory** for normalization purposes, such as when comparing traces "before" and "after" a change is made or when measuring trace noise. In the following table, the Data/Mem values intuitively show the differences between traces. It is not obvious what Data-Mem is displaying.

Values to compare	Data/Mem	Data-Mem
0.5 dB and 0.6 dB	0.1 dB	-39 dB
0.5 dB and 0.7 dB	0.2 dB	-33 dB

Use **Data - Memory** to show the relative differences between two signals. Use for comparison of very small signals, such as the S11 match of two connectors.

In the following table, Data/Mem shows both pairs of connectors to have the same 2 dB difference. However, the second pair of connectors have much better S11 performance (-50 and -52) and the relative significance is shown in the Data-Mem values.

Values to compare	Data/Mem	Data-Mem
-10 dB and -12 dB	2 dB	-24 dB
-50 dB and -52 dB	2 dB	-64 dB

File Management

The FieldFox can save any of the following types of files:

- Current settings and calibration
- Trace data (*.csv and *.S1P)
- Picture of the FieldFox screen

In addition, files can be saved to the internal memory, a USB Flash drive, or a micro SD card.

In this Chapter

Save Files	88
Recall Files	89
Set File Type and Device	90
Manage Files	91
Manage Folders	92
Edit Keywords	93
Prefixes for Filenames	93

See Also

Erase User Data	105
-----------------------	-----

Saving and Recalling Files

Save Files

How to Save a File

- Press **Save/Recall 9**.
- Then **Save**.
- At the top of the current 'labeler' screen (see following image) check the **File Type** to save and **Device** (Internal, USB, Storage Card) to which the file is saved. Learn how to change these settings on page 90.
- Then use the labeler to specify a filename.

How to name files

The labeler is used to edit or change the current filename. It is also used to create a title, prefix, and keyword to display on the FieldFox screen. Learn about Titles on page 98.

- Press **Select** to add the cursor character to the end of the existing filename.
- Press **Backspace** to erase the last character from the current filename.
- Press **Clear** to erase the current filename.

- The preselected keywords (File, Site, and so forth) can be selected just like a single character. These keywords can also be edited. Learn more on page 93.

Edit the filename. Press [Done] to save file.

File Type: Picture
 USB: \

Save:

A	B	C	D	E	F	G	H	I	J	K	L	M	N	O	P	Q	R	S	T
U	V	W	X	Y	Z	0	1	2	3	4	5	6	7	8	9	.	-	:	
GF		SITE		TOWER		TRACE		DATE											
ANTENNA1		ANTENNA2		COMPANY1		COMPANY2		COMPANY3											

Select Back Space Clear Cancel Done

The FieldFox labeler. The current filename is **GF2**. The cursor is on the custom **GF** keyword. The file will be saved to USB (flash drive). File Type is "Picture".

How to move the cursor

- Use the rotary knob to move cursor on the same row. The cursor will change rows when it comes to a row end.
- Use the **▲**/**▼** arrows to move the cursor up and down the rows.

When the current filename is complete

- Press **Done** to save the file to the specified filename. If the filename already exists, a warning is displayed.
- Press **Cancel** to close the labeler without saving a file.
- If the filename already exists, you are prompted to choose from the following:
 - Press **Yes** to overwrite the existing file.
 - Press **Cancel** to edit the filename.

Recall Files

State files and Trace + State files (*.sta) are the only file type that can be recalled by the FieldFox.

ALL FieldFox instrument settings for ALL Modes are saved and recalled in a *.sta file. If error correction is ON in CAT or NA Mode, then calibration data is also saved and recalled.

How to Recall an *.sta File

NOTE Before recalling a file, first set **File Type** to State or Trace + State, and also **Select Device** from which the file will be recalled.

- Press **Save/Recall 9**.
- Then **Recall**.
- Navigate to the file to be recalled using the Up/Down arrow keys.
- Then **Recall File** or **Enter**.

Set File Type and Select Device

The following File TYPE and DEVICE settings are used to determine the type of file to save, and the location to be used for all file operations.

These two settings remain through an instrument preset, but are reset to the default values when the FieldFox power is shutdown.

Select Device (location of File Save/Recall)

- Press **Save/Recall 9**.
- Then **Select Device** to set the **LOCATION** where the file is to be saved. Choose from the following:
 - **Internal** Saves/Recalls files to/from the FieldFox internal memory. To specify a folder, first select Manage Folders (learn how on page 92). The Data Link software will read data ONLY from the \UserData folder.
 - **SD Card** Saves/Recalls files to/from the micro SD card (not included), inserted in the card slot. See FieldFox Tour on page 14. Only the root folder is available.
 - **USB** Saves/Recalls files to or from a USB Flash drive (not included) that is inserted in one of the USB connectors. Only the root folder is available.

NOTE Insert only ONE USB Flash Drive in the FieldFox when saving or copying files.

How to set File Type

State files are the only file type that can be recalled by the FieldFox.

- Press **Save/Recall 9**.
- Then **File Type**. Choose one of the following:
 - **State** Saves ALL FieldFox instrument settings for ALL Modes to a *.sta file. If a calibration is ON in CAT or NA Mode, calibration data is also saved. This file can be opened ONLY by a FieldFox.
 - **Trace + State** Saves the current trace and instrument settings to a *.sta file. This file can be opened ONLY by a FieldFox. When recalled, the FieldFox sweep is set to Hold.
 - **Picture** Saves a 640 x 453 pixel image of the FieldFox screen to a *.png file. The picture does NOT include the softkeys.
 - **Data (S1P) / (2P)** Saves CAT and NA Mode trace data to an *.S1P or *.S2P file, depending on the active measurement. This file format is used by CAE programs such as Agilent's Microwave Design System (MDS) and Advanced Design System (ADS). It can also be imported into spreadsheet software such as Microsoft Excel.
- Choose S1P to save data for the active data trace.

- Choose S2P (NA Mode ONLY) to save the four S-parameters: S11, S21, S12, and S22. Zeros are returned for parameters that are not displayed, except if full 2-port correction is ON (option 122). In this case, corrected data for all S-parameters is returned, even if not displayed.

About SNP Files

- The SNP file includes header information, and the following data:
 - S1P - saves 1-port (receiver) data for the active data trace. *.s1p Files contain 1 stimulus value and 1 S-parameter (total of 3 scalar values) **Stim Real(Sxx) Imag(Sxx)**
 - S2P (NA Mode ONLY) - saves data for two S-parameters (S11, S21) if they are both displayed. *.s2p Files contain 1 stimulus value and 4 S-parameters (total of 9 scalar values) **Stim Real(S11) Imag(S11) Real(S21) Imag(S21) Real(S12) Imag(S12) Real(S22) Imag(S22)**
 - When parameters are corrected, data is returned even when not displayed. When parameters are NOT corrected or displayed, and the format is Mag/Phase, zero-filled data appears as 0 dB and 0 degrees. When the format is Real/Imaginary, zero-filled data appears as (1,0).
- Data is returned with the correction type that is applied for each S-parameter. The correction type for each S-parameter is annotated in the header.
- Only the data trace is saved – not the memory trace.
- In CAT Mode, S1P files are always Magnitude(dB) / Phase (angle) format.
- In NA Mode, SNP files for traces in Smith Chart or Polar format saves Real/Imaginary format. All other trace formats are saved in Mag/Phase format.
- Trace Math is ignored when saving data to an SNP file.
 -
 - **Data (csv)** Saves trace data from the current mode to a *.csv file. This format can be imported into spreadsheet software such as Microsoft Excel.
 - In **CAT Mode**, only the single data trace is saved – not the memory trace.
 - In **NA Mode**, all displayed data traces are saved – not the memory traces.
 - In **Power Meter and VVM Mode**, NO data is saved.

Manage Files

Files that are stored in the FieldFox internal memory, micro SD card, and USB Flash drive, can be copied to another device or deleted.

For **Copy File** and **Copy All** operations, files are always copied to the root directory of the destination device. They can NOT be copied to other folders. To get a file to another folder, it must be saved to the specified folder.

How to Manage files

- Press **Save/Recall 9**.

- Then **Select Device** to select the location (Internal, USB, or micro SD Card) of the file to copy or delete.

NOTE When selecting **Internal**, it may also be necessary to first select **Manage Folders** to specify an active folder which contains the files to copy or delete.

- Then **More**.
- Then **Manage Files**.
- Then choose from the following:
 - **Copy File** Select a file to copy. Then select a destination to copy the file to. Choose from **Internal**, **USB** (must be inserted), or **SD Card** (must be inserted). The file is copied to the root directory of the destination device.
 - **Copy All Files** All files that appear will be copied. Then select a destination to copy the files to. All of the displayed files are copied to a new folder at the root directory of the destination device. The new folder name is the current date-time.
 - **Delete File** The **selected** file is deleted after a warning prompt is displayed.

NOTE Insert only ONE USB Flash Drive in the FieldFox when saving or copying files.

Manage Folders

You can create new folders, delete old folders, and select the active folder to which files can be saved. The Parent folder [..] is listed when not in the root directory.

How to Manage Folders

- Press **Save/Recall 9**.
- Then **More**.
- Then **Manage Folders**.
- Then choose from the following:
 - **Change Folder** Changes the active folder to which files can be saved. The active device and current folder is displayed at the top of the screen. Use the **▲▼** arrows to highlight a folder within the current folder. Each time the **Change Folder** softkey is pressed, the highlighted folder becomes the active folder.
 - **Create Folder** A new folder is created in the current folder. Select a name for the new folder from one of the displayed keywords: You can change these keywords using the following **Edit Keywords** function.
 - **Delete Folder** The **selected** folder and its contents are deleted after a warning prompt is displayed. A “Parent” folder or system folder can NOT be deleted.
- Press **Exit** when finished.

Edit Keywords

The preselected keywords (FILE, SITE, and so forth) can be edited to meet your specific needs. Your keywords will remain in the FieldFox until you change them. Keywords are limited to 30 characters.

How to edit keywords

- Press **Save/Recall 9**.
- Then **More**.
- Then **Edit Keywords**.
- Then **Next Page** and **Previous Page** to view all keywords.
- Use the **▲|▼** arrows to select a keyword to edit.
- When a keyword is selected, then press **Edit**.
- Then choose from the following:
 - Press **Select** to add the cursor character to the end of the selected keyword.
 - Press **Backspace** to erase the last character from the end of the selected keyword.
 - Press **Clear** to erase the selected keyword.

How to move the cursor:

- Use the rotary knob to move the cursor along the same row. The cursor will change rows when it comes to a row end.
- Use the **▲|▼** arrows to move the cursor up and down between rows.

When the selected keyword is complete:

- Press **Done** to save all keywords and close the Edit Keywords labeler. These keywords will exist on the FieldFox until changed.
- Press **Cancel** to close the labeler without saving changes.

Prefixes for Filenames

A prefix is used as a default filename to which characters can be added. The prefix can be customized, and quickly enabled or disabled. When enabled, the current prefix is automatically entered as the start of a filename when performing a Save operation.

How to enable and disable the current Prefix

- Press **Save/Recall 9**.
- Then **More**.
- Then **Prefix ON OFF** The current selection is underlined.

How to edit the current Prefix

- Press **Save/Recall 9**.

- Then **More**.
- Then **Prefix**.
- Then choose from the following:
 - Press **Select** to add the cursor character to the end of the Prefix.
 - Press **Backspace** to erase the last character from the end of the Prefix.
 - Press **Clear** to erase the Prefix.
 - The preselected keywords (File, Site, and so forth) can be selected just like a single character. These keywords can also be edited. See **Edit Keywords**.

How to move the cursor

- Use the rotary knob to move cursor on the same row.
- Use the  arrows to move the cursor up and down the rows.

When the Prefix is complete

- Press **Done** to save the Prefix and close the labeler. This Prefix will exist on the FieldFox until it is changed.
- Press **Cancel** to close the labeler without saving changes.

Printing

You can NOT print the measurement display directly from the FieldFox to a printer. You can save a Picture file to a USB Flash Drive or micro SD card and then print from any computer. Measurements can also be printed using the FieldFox Data Link software. Learn more at:

http://na.tm.agilent.com/fieldfox/datalink_info.html

System Settings

In this Chapter

Run/Hold.....	95
Preset.....	96
Volume Control	96
Display Settings	96
Colors	97
Brightness.....	97
Trace Width.....	98
Title.....	98
Full Screen Mode.....	98
Edit Keywords	98
Preferences	
Language.....	99
Display	99
Battery Saver	100
System Configuration	
Options (Licensing)	100
GPS	101
External Frequency Reference	103
Date and Time Settings	103
LAN Settings	104
Service Diagnostics	105
Erase User Data.....	105

See Also

Battery Usage	11
FieldFox Internal Temperatures	12

Run/Hold

The **Run/Hold** key determines whether the FieldFox sweeps continuously or does NOT sweep, but holds the display results of the last sweep that was performed.

Use **Hold** to conserve battery power or to allow you to save or analyze the results of a specific measurement sweep.

The current sweep mode is shown on the screen as:

-  Continuous
- **Hold** Hold
- --> is displayed while a single sweep occurs.

How to perform a single sweep while in Hold

- Press **Sweep 3**.
- Then choose one of the following:
 - **Single** Automatically sets Continuous OFF (Hold) and causes FieldFox to make ONE measurement sweep, then hold for the next Single key press.
 - **Continuous** Makes continuous sweeps. This is the typical setting when battery power is not critical.

Preset

The Preset key restores the FieldFox measurement settings to a known condition. You can preset the entire instrument, or just the current Mode (CAT, Power Meter, NA.)

When Preset, the FieldFox becomes CalReady at the test ports. Learn more on page 52.

The following settings always survive Preset and/or Mode Preset:

- External Reference state (page 101);
- Marker Peak Excursion and Threshold (page 83).
- VVM Display Resolution (page 71).
- Volume Control

How to Preset the FieldFox

- Press **Preset**.
- Then choose one of the following:
 - **Preset** Returns ALL Modes to the factory default settings.
 - **Mode Preset** Returns only the current Mode to the factory default settings. The current settings for all other Modes remain.

Volume Control

System volume control is a FieldFox global setting which sets speaker volume for ALL success beeps, key press clicks, and individual features that use the FieldFox speaker, such as SA Mode Tune and Listen.

The volume control setting remains through a FieldFox Preset. To cause your volume control setting to remain through a FieldFox shutdown, save the setting as a Preference. Learn how on page 99.

How to set FieldFox Volume Control

- Press **System 7**
- Then **Volume**
- Then use the **▲|▼** arrows, the rotary knob, or numeric keypad to enter a value between 0 (lowest volume) and 100 (highest volume).

- Press **Volume** again and select **Mute** to quickly turn OFF the speaker volume. Press **Volume** again to set volume ON to the previous volume control.

Display Settings

You can adjust the FieldFox for optimum viewing in a wide range of lighting conditions.

Display settings remain through a FieldFox Preset. To cause the display brightness, color settings, and trace width to remain through a FieldFox shutdown, save the display settings as Preferences. Learn how on page 99.

NOTE Clean the transfective screen with gentle and minimal wiping using Isopropyl alcohol applied to a lint-free cloth.

Display Brightness

Change the brightness of the background.

How to set Display Colors

- Press **System**.
- Then **Display**.
- Then **Brightness**.
- Use the **▲|▼** arrows, the rotary knob, or numeric keypad to enter a value between 0 and 100%.

Display Colors

Change Display Colors to alter the viewing scheme.

How to set Display Colors

- Press **System**.
- Then **Display**.
- Then **Display Colors**.
- Then choose one of the following:

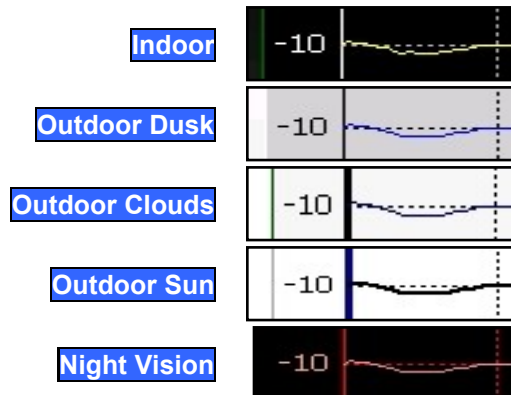

Trace Width

You can set width of all displayed traces on the FieldFox. This may allow better viewing or enhance the look of screen images. This setting can be saved with Preferences.

How to set Trace Width

- Press **System**.
- Then **Display**.
- Then **Display Colors**.
- Then **More**.
- Then **Trace Width**.
- Then choose one of the following:
 - **Normal** - Standard width.
 - **Wide** - Enhanced width.

Title

A custom title can be made to appear in the upper-left corner of the FieldFox screen. The title can contain up to approximately 65 alpha-numeric characters. To view the Title area, see the Screen Tour on page 17.

How to add or edit a Title

- Press **System**.
- Then **Display**.
- Then **Title**.
- Then enter or edit a title using the FieldFox labeler. This is the same labeler function that is used to name files. Learn how to use the labeler on page 88.
- Then **Title ON OFF** to make the title appear and disappear from the screen.

Edit Keywords

During a file save operation, keywords can be quickly appended to other text to create unique filenames. The Edit Keywords feature allows you to create custom keywords. Learn all about Edit Keywords on page 93.

Full Screen Mode

Full Screen Mode maximizes the display of the active trace. The screen annotations and the soft keys are removed.

How to set Full Screen Mode

- Press **System**.
- Then **Full Screen**.

To **Exit** full screen Mode, press any key.

Preferences

Language

Choose the language in which to display FieldFox softkeys and other messages.

How to select a Language

- Press **System 7**.
- Then **Preferences**.
- Then **Language**.
- Then choose from the following:
 - **English**
 - **Espanol** – Spanish
 - **Deutsch** – German
 - **Italiano** – Italian
 - **Francais** – French
 - **Russian**
 - **Japanese**
 - **Chinese**
 - **Turkish**

Save Preferences

You can save your Display settings, Volume Control setting, Battery Saver setting, and Time Zone setting as preferences that will remain set through a FieldFox shutdown.

In addition, the following GPS settings are saved as preferences: GPS state, data display state, elevation unit, and latitude/longitude format. Learn about GPS on page 101.

How to save current settings as Preferences

- Configure the settings as you would like them to remain. Learn about display settings on page 96.
- Press **System**
- Then **Preferences**
- Then **Save Current Settings** There is a beep when your settings have been saved.
- Press **Reset Preferences** to restore the factory default settings.

Battery Saver

When the battery saver is OFF, the source power is left ON at the end of the sweep which consumes more power. This feature is used in CAT, NA and VVM modes.

How to set Battery Saver

- Press **System**
- Then **Preferences**
- Then **Battery Saver**
 - **ON** – Default setting. To conserve battery power, the RF source power is turned OFF at the end of each CAT, NA, and VVM mode sweep. This behavior does not impact FieldFox measurements.
 - **OFF** – Source power is kept ON at all times, including during trigger Hold mode and between single sweep acquisitions. The RF source stays at the stop frequency until another sweep begins. This provides a constant, uninterrupted RF output from the current source port: PORT 1 with forward measurements or PORT 2 with reverse measurements (Opt 122). This behavior also provides the highest trace stability sweep-to-sweep which may only be evident while using either single sweep or Run/Hold. With Battery Save OFF, the use of a full battery charge is reduced by approximately 45 minutes.

System Configuration

Options (Licensing)

You can view and install options on your FieldFox. See all available options on page 7.

How to view the Installed Options

- Press **System**
- Then **System Configuration**
- Then **Options(Licensing)**
- Then **Show Options**

The currently installed options are listed.

How to Install Options

A .lic file must already be on a USB Flash Drive. To learn how to obtain a .lic file, visit: <http://www.agilent.com/find/softwarelicense>

Insert the USB Flash Drive in the FieldFox.

- Press **System**.
- Then **System Configuration**
- Then **Options**

- Then **Install Options** The FieldFox reads, validates, then installs the options.
- Press and hold the power button to shutdown, then restart the FieldFox.

For more information about Licensing, see the FieldFox Service Manual at <http://na.tm.agilent.com/fieldfox>.

GPS

GPS (Global Positioning System) allows you to ‘stamp’ each data trace with your physical position in latitude/longitude/elevation format. This can be useful when making measurements on cell towers or other antennas at remote locations.

NOTE This feature is usable ONLY with the GPS receiver that is shipped with Microsoft “Streets and Trips” and “AutoRoute”. The GPS receiver is NOT available from Agilent. Only the GPS USB receiver is used with the FieldFox. Therefore, it is NOT necessary to purchase the very latest version of the map software.

- GPS can be used in all FieldFox modes.
- Your GPS settings can be saved with Preferences. Learn more on page 99.

How to make GPS settings

- Press **System 7**
- Then **System Configuration**
- Then **GPS**
- Then choose from the following:
 - **OFF** - Disable GPS (default setting).
 - **External** - Enable GPS using an external, customer-supplied, USB dongle device. When enabled, a check is made to detect a USB GPS device at the USB connectors. When a device is detected, a search is made for satellites overhead. The GPS works best when outdoors and in full view of the open sky. When several satellites are found, the following screen appears and is updated frequently:

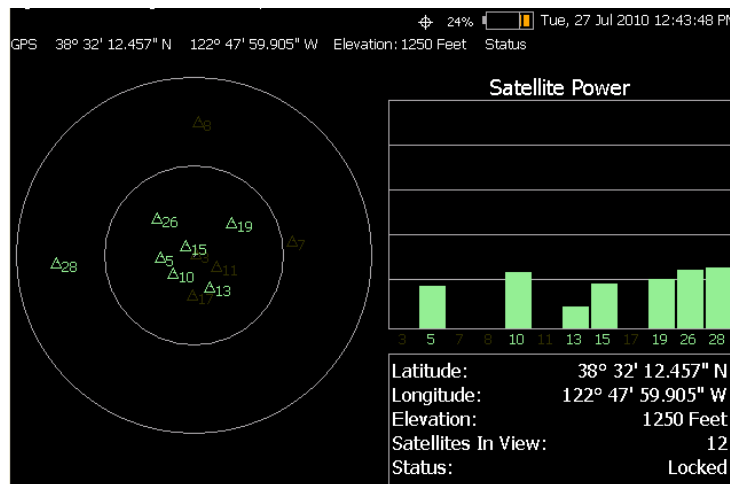

- The left portion of the screen shows satellites and the corresponding number on the adjacent Satellite Power chart.

- **Sync Clock ON OFF** Enable and disable the synchronization of the FieldFox internal clock to the GPS UTC time standard.
 - **ON** The FieldFox clock is synchronized and updated approximately every second to the time of the GPS clock. Learn how to set the local time zone on page 103.
 - **OFF** The FieldFox clock is NOT synched with GPS. When set to OFF after Sync was ON, the date and time does NOT revert back to the settings before the clock was synchronized.
- **Display ON OFF** Enable and disable the GPS display on the FieldFox main window.
- **Lat/Lon Format** Change the format of the GPS display on the FieldFox screen. Choose from:
 - **ddd°mm' ss.sss"** degrees, minutes, seconds (default setting)
 - **ddd°mm.mmmmm'** degrees, minutes, fractional minutes
 - **ddd.ddddddd°** decimal degrees
- **Elevation Unit** Choose from:
 - **m** (Meters)
 - **Feet**

GPS Status

With GPS enabled and a device detected, the following is displayed at the top of the FieldFox screen:

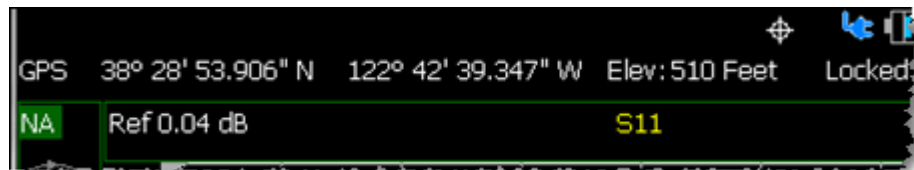

In the above image, the following icons show if the FieldFox is locked on satellites:

- ⊕ - GPS ON and locked on satellites
- ⊕? - GPS ON, but NOT locked on satellites
- +* - GPS ON, but no GPS receiver is present or detected

Saving Data with GPS Enabled

GPS position and clock data are included when data is saved with the following files types: *.csv, *.SnP, State, State+Trace data save.

A warning is shown if the GPS is ON but unlocked at time of save, or if the GPS feature is ON but no GPS is physically present at time of save.

The following is a sample S1P file with GPS information:

```
!GPS Latitude: 38 28.87717 N
!GPS Longitude: 122 42.66625 W
!GPS TimeStamp: 06/25/2010 16:24:48
!GPS Seconds Since Last Read: 2
```

External Frequency Reference

The FieldFox can phase lock with an external 10 MHz reference signal. When a high-stability 10 MHz reference signal is available, this can improve the accuracy and stability of measurements in CAT, NA, and VVM (transmission) Modes.

The External Reference setting will survive a FieldFox or Mode Preset and is saved as part of the Instrument State.

How to use an External Reference

Connect the 10 MHz External Reference to the **EXT TRIG/EXT REF** BNC connector on the FieldFox top panel. External Triggering is NOT available on the N9923A.

- Press **System 7**
- Then **System Configuration**
- Then **Frequency Ref**
- Then **Freq Ref Source Int Ext**

NOTE The FieldFox may take up to 10 seconds to lock to a valid External Reference source.

When switched to Ext, if the FieldFox does NOT find an appropriate signal with which it can lock, then **Ext Ref UNLOCKED** is displayed in the lower-left corner of the screen. This can occur when any of the following conditions exist:

- NO external reference signal is present.
- A low-level external reference signal is present.
- A very high-level external reference signal is present.
- The external reference is off-frequency.

For best results, the signal should be between -5 dBm and +5 dBm.

Date and Time, Format, and Time Zone Settings

Set the local Date and Time, Date and Time format, and Time Zone that is shown on the FieldFox screen. The Date and Time is also used to identify files that are saved.

Your Time Zone setting can be saved with Preferences. If it is NOT saved with Preferences, then it is reset when the FieldFox is powered OFF and ON.

The Date and Time can also be set by synchronizing with GPS satellites. Learn more on page 101.

How to set Date and Time, Date and Time Format, and Time Zone

- Press **System 7**.
- Then **System Configuration**.
- Then **Date and Time**.
- Press the **▲▼** arrows to highlight the row to be edited.
- Then **Edit**.
- Use the rotary knob to highlight the field to be edited.

- Use the **▲|▼** arrows or numeric keypad to edit that field.
- Press **Cancel** or **Done** when the edits are complete.
- Press **Done** to exit the Date and Time settings. The readout in the upper-right corner of the FieldFox screen will update accordingly.

NOTE Although allowed during entry, year settings higher than 2088 will not be changed on the screen.

LAN Settings

Configure the LAN settings to be used to communicate with the Data Link Software. Learn more at: http://na.tm.agilent.com/fieldfox/datalink_info.html

Use knob. Press [Edit] to make changes. Press [Done] to exit.	
Setting	Value
Current IP Address	192.168.1.102
Current Subnet Mask	255.255.255.0
Current Gateway	192.168.1.1
Hostname	A-N9912A-00000
Obtain IP Address using:	DHCP
Static IP Address	123.456.789.123.123
Static Subnet Mask	0.0.0.0
Static Gateway	0.0.0.0
Apply Settings at:	PowerUp

LAN Settings

How to configure the LAN settings

The first three 'Current...' settings can NOT be edited.

- Press **System 7**.
- Then **System Configuration**.
- Then **LAN**.
- Use the **▲|▼** arrows to select one of the following, then press **Edit**.
 - **Hostname** Change the name that can be used to address the FieldFox if your server supports this feature. The default hostname is generated automatically.
 - **Obtain IP** Choose from:
 - **DHCP** - IP Address is assigned dynamically. If your server supports this feature, the IP Address for the FieldFox is assigned each time it is started.
 - **Static** - Set the IP Address manually. The Address remains until you change it.
 - **Static IP Address** - Enter the IP Address – including periods - in the format nnn.nnn.nnn.nnn
 - **Static Subnet Mask** - Enter the Subnet Mask – including periods - in the format nnn.nnn.nnn.nnn
 - **Static Gateway** - Enter the Static Gateway – including periods - in the format nnn.nnn.nnn.nnn
 - **Apply Settings** Choose from:

- **Power Up** The above settings take effect when the FieldFox is started.
- **Now** The above settings take effect immediately.

NOTE To make the LAN settings persist after power up, toggle **Apply Settings to Now** then back to **Power Up**. You should see a message indicating that the LANconfig file was saved.

- Press **Done Edit** when finished.

Service Diagnostics

- The Service diagnostics menu is generally used to display service-related information. To access these menu items, press **System 7** then **Service Diagnostics**.

System Information

The System information table shows important information about your FieldFox. The following is the most useful information:

- **Model Number** – FieldFox model
- **Serial Number** – Identification number of your FieldFox
- **Firmware Release** – The currently installed version of software. Check to see if you have the latest firmware at: <http://na.tm.agilent.com/fieldfox/>
- **Network Identity** – The network name and current IP address of your FieldFox.

Error Log

The Error Log shows the information that has appeared on the FieldFox screen. The most recent information is at the top of the table.

Press **Clear Errors** to erase this information.

Battery

Learn about this table on page 107.

Internal Temperatures

Learn all about this table and the importance of the internal FieldFox temperatures on page 12.

Erase User Data

All data that you have written to the FieldFox can be erased with the press of a button. You would do this if your FieldFox is located in a secure environment and must be routinely erased of sensitive data.

All data is deleted from the FieldFox internal “UserData” partition. This includes all State files and Trace + State files (*.sta), all Data files (*.csv, *.snp), all Picture files (*.png), all Cal Kit files, and all Cable files.

External media that is inserted (mini-SD card or USB flash drive) is NOT erased.

The "Lost Clusters" folder and files is NOT erased because it is part of the file system housekeeping.

How to Erase User Data

- Press **System 7**.
- Then **Service Diagnostics**.
- Then **Advanced**
- Then **Erase User Data**
- Then **Confirm Erase**
- Then the following occurs:
 - All data files and folders are deleted from the "UserData" partition.
 - A large file of 0s is written to all of the free blocks on the partition.
 - The large file is deleted. All blocks released by deleting this file are now available for use.

The FieldFox is rebooted, which manages the newly-freed data and re-writes the factory cal kits and cable files.

Debug Value

Used by Agilent Service Personnel only.

Working with the Lithium-Ion Battery

In this Chapter

Viewing Battery Charge Status.....	107
Charging the Battery	109
Reconditioning the Battery	110
Battery Care	110
Maximizing Battery Life	112
Battery Disposal.....	112



See Also

Installing the Battery	11
Conserving Battery Power	11
Battery Safety Considerations.....	123

Viewing Battery Charge Status

You can view the battery charge status in the following ways:

- Icons in the upper right of the front panel screen.
- Battery screen - select **System** then **Service Diagnostics** then **Battery**.
- Built-in battery gauge. Open the FieldFox battery compartment door to view the battery LCD.
-

Icon	Status
	Connected to external power through the AC/DC adapter. Battery installed and charging. The amount of charge is indicated by the number of bars shown.
	Battery not charging with 84% battery life remaining.
	Battery fully charged. A fully charged battery MAY NOT read 100%. Learn more on page 110, Reconditioning the Battery.

Service Diagnostics – Battery Screen

The Battery screen displays the following information. To access the screen, select **System** then **Service Diagnostics** then **Battery**.

1. **Status** – Fully charged, No battery, Charging, Empty, or Discharging.
2. **External DC Supply** – true or false tells you if an external DC supply is connected.
3. **Battery Present** – true or false tells you if a battery is installed.

NOTE Items 4 through 15 are read directly from the battery. The information is based on the battery's internal sensors and memory.

4. **Battery Voltage** – measured by the battery's sensor.

5. **Current** – amount of current being consumed when operating from internal battery. If battery is charging, indicates amount of charging current.
6. **Average Current** – running average of current, as just explained in item #5 .
7. **Battery Temperature** – internal temperature of the battery as measured by a sensor embedded in the battery.
8. **Max Error** – present accuracy of the battery gauge. If the error exceeds 10%, you should recondition the battery. Learn more on page 110.
9. **Relative State of Charge** – current charge compared to actual full capacity. This number lowers with age and number of battery cycles.
10. **Absolute State of Charge** – current charge compared to designed full capacity of a new battery.
11. **Remaining Capacity** – number of amp hours remaining.
12. **Full Charge Capacity** – number of amp hours when fully charged.
13. **Present Run Time to Empty** – minutes of run time remaining based on amount of current being used now.
14. **Average Run Time to Empty** – minutes of run time remaining based on running average of current being used.
15. **Charge Cycles** – number of charge cycles battery has experienced. Charge cycle defined as $\geq 80\%$ change in relative state of charge.

Built-In Battery Gauge

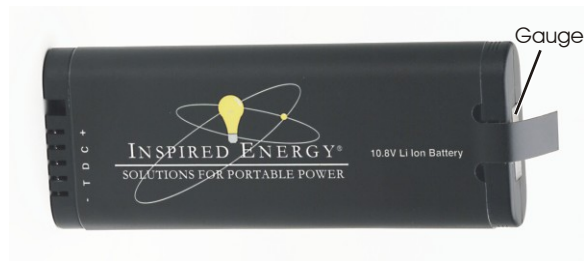

Each lithium ion battery has an LCD gauge that displays its charge status. Each segment represents 20% of the charge capacity. The gauge is active unless the battery is in shutdown mode. To view the LCD gauge on the Inspired Energy battery, open the FieldFox battery compartment door.

Gauge	Charge Remaining
5 segments	$\geq 80\%$
4 segments	$\geq 60\%$, $< 80\%$
3 segments	$\geq 40\%$, $< 60\%$
2 segments	$\geq 20\%$, $< 40\%$
1 segment	$< 20\%$

Charging the Battery

When you receive your FieldFox, the lithium-ion battery is partially charged to approximately 30% to 40% to preserve battery life. Allow four hours to fully charge the battery internally, or three hours by using the external battery charger (N9910X-872). A fully charged battery will power your FieldFox for about four hours. It is NOT necessary for you to do any type of battery preconditioning before use.

The FieldFox circuitry ALWAYS prevents the battery from discharging to a level that is damaging. However, if the battery is **completely** discharged, the FieldFox may not turn ON. If this occurs, the battery can still be charged either internally or externally.

Because a lithium-ion battery has no memory effect, you can charge a battery at any time regardless of the current charge status. However, this could impair the accuracy of its internal charge-remaining indicator. When the Max Error is greater than 10%, the battery should be reconditioned. Learn more on page 110.

Internal Charging with the AC/DC Adapter

Important: Read the safety information for the AC/DC adapter on page 121.

Internal charging time for a fully depleted battery is approximately 4 hours with the FieldFox either ON or OFF.



AC/DC adapter

To charge a battery inside the FieldFox, insert the AC/DC adapter plug into the Power connector on the FieldFox side panel (middle hinged door), then plug the adapter into an AC outlet.

- FieldFox ON: Charging is indicated by a battery icon in the upper right of the front panel screen. The icon shows 100% when charging is done.
- FieldFox OFF: Charging is indicated by the FieldFox power LED glowing amber, with its intensity increasing from dim to bright every few seconds. This pattern repeats until the LED turns off when charging is done. Learn more on page 15.

Using the External Battery Charger (N9910X-872)

Important: Read the safety information for the External Charger on page 122.



External Battery Charger (N9910X-872)

The external battery charger (N9910X-872), lets you charge a fully depleted battery in approximately three hours. It is a two bay, level-3 stand-alone battery charger that is compliant with the standard Smart Battery System. The two bays are charged sequentially on a first-come, first-served basis, though a discharge can be performed in the left bay while the right bay is charging. It uses an external universal switching power supply

External Battery Charger LED	Charging Status
Green	Fully charged
Green flashing	Fast charging
Yellow flashing	Reconditioning – the accuracy of the battery’s internal LED charge gauge is being renewed. See “Reconditioning Batteries.”
Yellow/green	Battery is reconditioned
Red flashing	Error
Yellow	Standby

For more information, refer to the Instruction Manual included with the external battery charger.

Reconditioning the Battery

The battery contains electronics that monitors battery usage and tracks how much capacity is available. This function can become less accurate because of temperature fluctuations, aging, self-discharge, repeated partial charging, and other factors. Reconditioning - also known as recalibrating - restores the accuracy of the battery capacity tracking system.

Reconditioning does NOT affect actual battery performance. It only recalibrates the charge level indicator.

Reconditioning is done by fully charging the battery, fully discharging it, recharging it again, and then verifying that the error has been corrected.

How to determine if a battery needs reconditioning

1. Press **System** then **Service Diagnostics** then **Battery**.
2. On the Battery screen, if the Max Error is 10% or greater, the battery needs to be reconditioned.

This error will affect many of the displayed battery charge indicators.

After reconditioning, if the battery is not fully charged or continues to show more than a 9% Max Error reading, repeat the reconditioning procedure.

If the third reconditioning does not restore a full charge and give an error reading of 9% or less, the battery may need replacement.

You can recondition a battery internally, or with the External Charger (N9910X-872). The external charger process is faster and simpler.

How to perform Internal Reconditioning

1. Fully charge the battery inside the FieldFox (either ON or OFF) using the AC/DC adapter.
2. Confirm that the battery is fully charged. When fully charged, the following icon appears on the FieldFox: 
3. Fully discharge the battery by disconnecting the AC/DC adapter, then leave the FieldFox ON until it shuts down (about four to five hours).
4. Remove the battery from the FieldFox, wait one minute, then re-install the battery.
5. Reconnect the AC/DC adapter.
6. Charge the battery and verify a full charge.
7. Check the **System** then **Service Diagnostics** then **Battery** screen to verify that the Max Error is less than 10%.

How to Recondition with the External Battery Charger (N9910X-872)

1. Insert a battery into the left bay of the external charger.
2. Press the button labeled Push to Recalibrate Left Battery Bay
3. The charger will charge the battery fully, discharge it completely, then recharge it fully again. The entire process can take up to 12 hours.
4. Install the battery into the FieldFox.
5. On the System, Battery screen, verify that the battery is fully charged and reconditioned.

Battery Care

Visually inspect the battery periodically for signs of degradation, such as swelling, cracking of the battery shell, or leakage of fluid. If degradation occurs, replace the battery and dispose of it properly. Learn how on page 112. Operation with a degraded battery could result in damage to the FieldFox. Learn more on page 123.

Maximizing Battery Life

- If AC power is continuously available (Ex: in a workbench environment), remove the battery and use the AC/DC adapter.
- If AC power is not continuously available (Ex: in a field environment), use the battery and recharge it when it holds a 20% to 50% charge, as shown on the screen's battery charge icon. At this charge level, 2 or 3 segments show on the battery gauge.
- If the FieldFox is not going to be used for more than a week, remove the battery. Best practice is to store the battery with a charge of about 50%. At this charge level, 3 segments show on the battery gauge. Batteries that remain idle eventually lose their ability to hold a charge.
- Allow a battery to warm to room temperature before charging it. Temperature shock can damage the battery chemistry and in some cases cause a short circuit.
- Store batteries in a cool, dry location, away from metal objects and corrosive gases.
Storage temperature limits (20% to 50% relative charge is recommended):

Transportation:	-20°C to 50°C
Within 1 month:	-20°C to 45°C
Within 6 months:	-20°C to 40°C
Within 1 year:	-20°C to 35°C
- Battery charging limits:

Charge temperature:	0°C to 45°C (<10°C slows charge on some batteries)
Discharge temperature:	-10°C to 60°C
- Operate the FieldFox on battery power between the ambient temperatures of -10 and +50°C (-14 to +122°F). Using the battery at lower or higher temperatures can damage it and reduce operating life. Cold temperatures affect battery chemistry, reducing charge capacity, especially below 0°C (32°F).

Lithium Ion Battery Disposal

When you notice a large decrease in charge capacity after proper recharging, it's probably time to replace the battery.

Lithium-Ion batteries need to be disposed of properly. Contact your local waste management facility for information regarding environmentally sound collection, recycling, and disposal of the batteries. Regulations vary for different countries. Dispose of in accordance with local regulations.

Agilent Technologies, through Rechargeable Battery Recycling Corporation (RBRC), offers free and convenient battery recycling options in the U.S. and Canada. Contact RBRC at 877-2-RECYCLE (877.273.2925) or online at: <http://www.call2recycle.org/> for the nearest recycling location

Hardkey/Softkey Menus

This section shows the FieldFox Hardkey and Softkey menu structure for **ALL options installed**. Your FieldFox may not include all of these menu items.

The following conventions are used in the FieldFox and in this manual:

- **Grey** bordered indicates front panel hardkey selections. Hardkeys are dedicated keys that do not change functionality.

The following softkeys change dynamically:

- **Blue** indicates available settings.
- **Black** indicates the factory default or currently selected setting.
- **Green** indicates more settings are available at a new menu level.
- **Yellow** indicates an active entry is in process.
- **On Off** Underlined items indicate current setting. Press to toggle between settings.
- **Resolution [201]** Brackets indicate the factory default or current setting. Press to select a different setting.

Mode

CAT Cable and Antenna Test

Power Meter Power Meter

NA Vector Network Analyzer

VVM Vector Volt Meter

Freq/Dist

CAT	Power Meter	NA Mode	VVM
All Meas except DTF Start Stop Center Span	Frequency	Start Stop Center Span	Frequency
All DTF Modes ONLY Start Distance Stop Distance Min Start Freq Max Stop Freq Settings More Max Freq Span			

Center Freq			
DTF Units			
Back			

Scale/Amptd

CAT	Power Meter	NA Mode	VVM
Autoscale Scale/Div Ref Level Ref Pos Top Bottom	Relative On Off Offset On Off Offset Val Scale Min Scale Max More Unit dBm (dB) Watt (%) Back Autoscale Resolution 0 1 2 3 Back	Autoscale Autoscale All Scale Ref Level Ref Pos More Electrical Delay Phase Offset Back	Resolution

Marker

CAT	Power Meter	NA Mode	VVM
Marker 1 ,2,3,4,5,6 Off Normal Delta Marker Table On Off More Marker 1 ,2,3,4,5,6 Markers (All Off) Marker Trace Auto Data Mem Back	None	Marker 1 ,2,3,4,5,6 Off Normal Delta Marker Table On Off More Marker 1 ,2,3,4,5,6 Markers All Off Marker Trace Auto Data Mem (Smith and Polar Formats Only) Marker Format Coupled Markers Back	None

Mkr =>/ Tools .

CAT	Power Meter	NA Mode	VVM
Peak Next Peak Peak Left Peak Right All except DTF Mkr=>Center More Min Search Peak Excursion Peak Threshold Back DTF ONLY More Marker=>Start Distance Marker=>Stop Distance Track Peaks ON OFF Find 3 Peaks Back	None	Marker Search Tracking ON OFF Peak Min Target Bandwidth Bandwidth ON OFF Mkr-> Mkr->Center Mkr->Delay Back Peak Searches Peak Next Peak Peak Left Peak Right Peak Criteria Peak Excursion Peak Threshold Back Back	None

Measure 1

CAT	Power Meter	NA Mode	VVM
Distance to Fault Return Loss & DTF Return Loss(dB) VSWR DTF (VSWR) More Cable Loss (1-Port) Insertion Loss (2-Port) DTF (Lin) Back	None	S11 S21 S12 S22 Format Log Mag Linear VSWR Phase Smith More Polar Group Delay	1-Port Cable Trimming 2-Port Transmission

		Unwrap Phase More A B R1 R2 Source Port Auto Port1 Port2	
--	--	---	--

BW 2

CAT	Power Meter	NA Mode	VVM
Average 1	Averaging On Off Num Averages	Average 1 IF BW 300 Hz 1kHz 3 kHz 10 kHz 30 kHz Smoothing ON OFF Sm Aperture 1.50%	IF BW

Sweep 3

CAT	Power Meter	NA Mode	VVM
Single Continuous On Off Restart Resolution 101 [201] 401 601 801 1001 MinSwpTime 0.0	Single Continuous On Off	Single Continuous On Off Restart Resolution 101 [201] 401 601 801 1001 MinSwpTime 0.0	None

Meas Setup 4

CAT	Power Meter	NA Mode	VVM
Settings Output Power High Low Interference Rej. Off Minimum Medium Maximum DTF 'Settings' ONLY DTF Window	Averaging On Off Num Averages Unit dBm (dB) Watt (%) Back Relative On Off Frequency	Settings Calibration (Settings) Output Power High Low Port Extensions Port Extensions ON OFF Velocity Factor 1.00 Back	Zero Zero Off Hold Single Continuous ON OFF More Restart Avg 1

DTF ONLY DTF Cable Specs Velocity Factor Cable Loss Cable Corr Auto Man Recall Coax Cable View Cable Data Back Frequency Mode Bandpass 'DTF & Return Loss' ONLY Alternate Sweep			Back
---	--	--	------

Cal 5

CAT	Power Meter	NA Mode	VVM
See page 53	Ext Zero	See page 53	

Trace 6

CAT	Power Meter	NA Mode	VVM
Data =>Mem Data Memory Data & Memory All except DTF Data Math Math Off Data + Mem Data - Mem Data / Mem Back	None	Trace 1, 2, 3, 4 Num of Traces x1, x2, x2H, x3H, x4 Math and Memory Data =>Mem Data Memory Data & Memory Data Math Math Off Data + Mem Data - Mem Data / Mem	None

System 7

Save/Recall 9

All Modes	All Modes
Display Display Colors Outdoor Sun	Save Shows labeler Select BackSpace

Outdoor Dusk	Clear
Outdoor Clouds	Cancel
Indoor	Done
Night Vision	Recall Shows list of files
Back	Recall File
Brightness	Sort by Name
Title	Sort by Date
Title On Off	Next Page
Edit Keywords	Previous Page
Back	Cancel
Full Screen	Device
Preferences	Internal
Language See the list of languages on page 99.	SD Card
Save Current Preferences	USB
Reset Preferences	File Type
Battery Saver ON OFF	State
Back	Trace + State
System Configuration	Picture
Options (Licensing)	Data (SNP)
Show Options	Data (CSV)
Install Option	More
Back	Manage Files Shows files
GPS	Copy File
OFF External	Copy All Files
Sync Clock	Delete File
Display ON OFF	Cancel
Lat/Lon Format	Manage Folders
Elevation Unit	Change Folder
Frequency Ref	Create Folder
Freq Ref Source Int Ext	Delete Folder
Back	Exit
Date and Time	Prefix Shows labeler
LAN	Prefix ON OFF
Service Diagnostics	Edit Keywords Shows keywords
System Information	Edit Shows labeler
Error Log	Cancel
Next Page	Done
Previous Page	
Clear Errors	
Battery	
Internal Temperatures	
Advanced	

Erase User Data	
Back	

Limit 8

CAT	Power Meter	NA Mode	VVM
Edit Left Right Clear Limit All Limits Off Exit Save Limits Recall Limits Options Beep ON OFF Warning ON OFF Back	Min Limit ON OFF Min Limit Value Max Limit ON OFF Max Limit Value	Edit Left Right Clear Limit All Limits Off Exit Save Limits Recall Limits Options Beep ON OFF Warning ON OFF Back	None

Preset .

All Modes
Preset Mode Preset

Run / Hold +/-

All Modes
Press to toggle between Continuous and Single sweep.

Safety Considerations

Agilent has designed and tested the FieldFox in accordance with IEC Publication 61010–1:2001 Safety Requirements for Electrical Equipment for Measurement, Control and Laboratory Use, and the FieldFox is supplied in a safe condition. The FieldFox is also designed for use in Installation Category II and pollution Degree 2 per IEC 61010 and IEC 60664 respectively. Read the following safety notices carefully before you start to use this FieldFox to ensure safe operation and to maintain the product in a safe condition.

For the FieldFox

WARNING

No operator serviceable parts inside except for the lithium-ion battery. Refer servicing to qualified personnel. To prevent electrical shock do not remove covers.

WARNING

If this product is not used as specified, the protection provided by the equipment could be impaired. This product must be used in a normal condition (in which all means for protection are intact) when attached to the AC-DC adapter.

WARNING

The unit may be used only in the operating conditions and positions specified by the manufacturer. The Agilent N9923A complies with the following standards

IEC 61010 2nd Edition/EN 61010 2nd Edition

Canada: CSA C22.2 No. 61010–1–04

USA: UL 61010–1 2nd Edition

WARNING

Do not install substitute parts or perform any unauthorized modification to the product. Return the product to Agilent Technologies or a designated repair center for service to ensure that safety features are maintained.

WARNING

Applicable local or national safety regulations and rules for the prevention of accidents must be observed in all work performed.

WARNING

Ensure that the connections with information technology equipment comply with IEC950 / EN60950.

WARNING

Observe all ratings and markings of the instrument before connecting the instrument.

Maximum Input Voltages and Power:

PORT 1 Connector: ± 50 VDC, +23 dBm RF

Ext Trig/Ref Connector: 5.5 V DC

PORT 2 Connector: ± 50 VDC, +23 dBm RF

DC Input: 19VDC, 4ADC

WARNING

When performing a measurement, ensure that the right safety and performance ratings of the instrument and accessories are used.

Do not expose the circuit or operate the instrument without its cover or while power is being supplied.

Do not operate the instrument in any environment at risk of explosion.

CAUTION

The power cord and connectors shall be compatible with the connector used in the premise electrical system. Failure to ensure adequate earth grounding by not using the correct components may cause product damage and serious injury.

CAUTION

The measuring terminals on this instrument are designed to be used with external signals described in Measurement Category I, but NOT with external signals described in Categories.

For the AC/DC Adapter

WARNING

The AC/DC adapter is a Safety Class 1 Product (provided with a protective earthing ground incorporated in the power cord). The mains plug shall only be inserted in a socket outlet provided with a protective earth contact. Any interruption of the protective conductor inside or outside of the product is likely to make the product dangerous. Intentional interruption is prohibited.

WARNING

Use only the designated AC/DC adapter supplied with the instrument.

WARNING

Use only the designated power cord supplied with the AC/DC adapter.

WARNING

No operator serviceable parts inside this product. Do not perform any unauthorized modification to the product. Return the product to Agilent Technologies or a designated repair center for service to ensure that safety features are maintained.

WARNING

Operated at an ambient temperature: 0 to 40°C; full power rating; derate linearly to 50 W at 50°C.

Maximum output rating: +15V/4.0 A.

Input rating: AC 100–240 V, 50/60Hz

WARNING

Main Plug : Use a 3–pin main plug that complies with IEC 60884–1, Plugs and Socket–Outlets for Household and Similar Purposes – Parts1: General Requirements and country specific safety authority requirements, such as UL, SA, BSI, VDE, CCC, SA, NZ, and PSE.

WARNING

Appliance Connector: Use an appliance connector certified to IEC 60320–1/EN 60320–1 requirements

WARNING

To prevent electrical shock, disconnect the AC to DC adapter from the mains before cleaning. Use a dry cloth or one slightly dampened with water to clean the external case parts. Do not attempt to clean internally.

WARNING

When the FieldFox is connected to the AC/DC adapter, position the adapter so the power cord is readily accessible. The power cord is the disconnecting device. It removes main power to the AC/DC adapter. The FieldFox front panel switch is only for the DC power within the instrument, and not for the AC/DC adapter. Alternately, an AC switch or circuit breaker (which is readily identifiable and is easily reached by the operator) may be installed and used as a disconnecting device to remove mains power from the AC/DC adapter.

WARNING

To avoid overheating, always disconnect the FieldFox from the AC/DC adapter before storing the FieldFox in the backpack.

If you prefer to leave the FieldFox connected to the AC/DC adapter while inside the backpack, you can disconnect the AC/DC adapter from its AC power source to prevent overheating.

CAUTION

The AC/DC adapter has an auto-ranging line voltage input – be sure the supply voltage is within the specified range.

CAUTION

The AC/DC adapter is for indoor use only.

CAUTION

Never use a modified or damaged charger. Use the original AC–DC adapter ONLY.

CAUTION

The AC/DC adapter is designed for use in Installation Category II and Pollution Degree 2 per IEC 61010 Second Edition.

For the External Battery Charger (N9910X–872)

CAUTION

If charging batteries externally, use the optional external charger available from Agilent, or another SMBus charger of level II or higher.

Never use a non–SMBus charger because the battery issues commands over the SMBus to the charger to control the charge rate and voltage.

Never use a modified or damaged charger.

For the Battery

Lithium battery packs may get hot, explode, or ignite and cause serious injury if exposed to abuse conditions. Be sure to follow these safety warnings:

WARNING

Lithium-ion batteries:

Must not be exposed to high temperatures (>70°C) or fire.

Must be kept away from children.

Must not be short circuited.

Must be replaced only with Agilent qualified Li-ion batteries.

If replaced or charged improperly, there is a danger of explosion.

WARNING

Do not connect the positive terminal and negative terminal of the battery to each other with any metal object (such as wire).

WARNING

Do not carry or store the battery with necklaces, hairpins, or other metal objects.

WARNING

Do not pierce the battery with nails, strike the battery with a hammer, step on the battery, or otherwise subject it to strong impacts or shocks.

WARNING

Do not solder directly onto the battery.

WARNING

Do not expose the battery to water or salt water, or allow the battery to get wet.

WARNING

Do not disassemble or modify the battery. The battery contains safety and protection devices, which if damaged, may cause the battery to generate heat, explode, or ignite.

WARNING

Do not place the battery in direct sunlight, or use or store the battery inside cars in hot weather. Doing so may cause the battery to generate heat, explode, or ignite. Using the battery in this manner may also result in a loss of performance and a shortened life expectancy.

WARNING

There is a danger of explosion if the battery is incorrectly replaced. Replace only with the same or equivalent type of battery recommended. Discard used batteries according to manufacturer's instructions.

WARNING

If you are charging the batteries internally, even while the FieldFox is powered off, the FieldFox may become warm. Allow for proper ventilation.

WARNING

Do not discharge the battery using any device except the FieldFox or the external battery charger (N9910X-872). When the battery is used in a device other than those specified, it may damage the battery or reduce its life expectancy. If the device causes an abnormal current to flow, it may cause the battery to become hot, explode, or ignite and cause serious injury

Battery Protective Functions

The following protective functions are designed into the lithium-ion rechargeable battery system used in FieldFox.

The protective functions can be divided between two categories: active and passive. Active protection refers to the type of protection that depends on at least two or more protection devices working together to enable the protection. Passive protection refers to the type of protection that is always enabled independent of any other protection device.

Active Protection

Primary Overcharge Voltage: This prevents the battery from being charged if the voltage across any cell exceeds approximately 4.35 V per cell. Once the overcharge protection is tripped, the voltage across each cell must drop below approximately 4.15 V to reset the protection and permit charging.

Secondary Overcharge Voltage: This is a one-time, permanent protection that is triggered when the voltage across any cell exceeds approximately 4.45 V. Once this protection is tripped, the battery can no longer be used and must be replaced.

Overdischarge Voltage: This prevents the battery from discharging if the voltage across any cell drops below approximately 2.6 V. Once the overdischarge voltage protection is tripped, the voltage across each cell must be charged to approximately 3 V to reset the protection and permit discharging.

Primary Overcharge Current: This prevents the battery from being charged if the average charging current reaches or exceeds 3.5A for a time period of 120 seconds or more.

Secondary Overcharge Current: This prevents the battery from being charged if the charging current reaches or exceeds $4A \pm 20\%$ for a time period of 20 milliseconds or more.

Primary Overdischarge Current: This prevents the battery from being discharged if the average current out of the battery reaches or exceeds 5A for a time period of 120 seconds or more. This protection can be reset by removing the load.

Secondary Overdischarge Current: This prevents the battery from being discharged if the current out of the battery reaches or exceeds 6A for a time period of 20 milliseconds or more. This protection can be reset by removing the load.

Short Circuit Protection: This prevents the battery from being charged or discharged and protects against damage or lost data if the current in or out of the battery reaches or exceeds 12.5A for a time period of 183 microseconds or more. This protection can be reset by removing the load.

Overtemperature Charging: The system microcontroller prevents the battery from being charged if the cell temperature exceeds 46C. Once the overtemperature charging protection is tripped, the cell temperature has to drop to or below 45C to reset the protection and permit charging.

Overtemperature Discharging: The system microcontroller prevents the battery from being discharged if the cell temperature exceeds 65C. Once the overtemperature discharging protection is tripped, the battery is automatically shut off which results in turning off the instrument as well.

Passive Protection

Reverse Charging: A reverse protection diode prevents against damage or lost data due to a reverse charge polarity applied to the battery terminals.

Primary Overtemperature: A PTC(positive temperature coefficient) polyfuse in series between the Li-ion cells and the charging and discharging transistors will open up and limit current flow to the battery terminals as a function of very high temperatures. This protection is resettable once the overstress condition is removed.

The maximum operating temperature of this fuse is 85C.

Secondary Overtemperature: A second PTC polyfuse built into each Li-ion cell will open up and limit current flow as a function of very high temperatures.

Tertiary Overtemperature: A current interrupt device (CID) within each Li-ion cell will permanently open up when the temperature reaches 95C. As each cell fuse is permanently interrupted, overall battery performance will become severely degraded, up to and including disabling the battery.

Overcurrent Fuse: This is a one-time blow fuse with a rated current of 12A.

Batteries: Safe Handling and Disposal

Product Information Sheet

Panasonic Batteries

Panasonic Industrial Company
A Division of Panasonic Corporation of North America
Two Panasonic Way
Secaucus, NJ 07094
Toll Free: 877-726-2228
Fax: 847-468-5750
e-mail: pembatteries@us.panasonic.com
Internet: www.panasonic.com/batteries

Product: Lithium-ion Batteries (Li-ion)

Applicable models/sizes: All

Revision: F; Dated 10/01/04

The batteries referenced herein are exempt articles and are not subject to the OSHA Hazard Communication Standard requirement. This sheet is provided as a service to our customers.

MSDS

Material Safety Data Sheets (MSDS) are a sub-requirement of the Occupational Safety and Health Administration (OSHA) Hazard Communication Standard, 29 CFR Subpart 1910.1200. This Hazard Communication Standard does not apply to various subcategories including anything defined by OSHA as an "article". OSHA has defined "article" as a manufactured item other than a fluid or particle; (i) which is formed to a specific shape or design during manufacture; (ii) which has end use function(s) dependent in whole or in part upon its shape or design during end use; and (iii) which under normal conditions of use does not release more than very small quantities, e.g. minute or trace amounts of a hazardous chemical, and does not pose a physical hazard or health risk to employees.

Because all of our batteries are defined as "articles", they are exempt from the requirements of the Hazard Communication Standard, hence a MSDS is not required.

The following components are found in a Panasonic Lithium Ion battery:

Component	Material	Formula
Positive Electrode	Lithium Cobalt Oxide	LiCoO ₂
Negative Electrode	Graphite	C
Electrolyte	Ethylene Carbonate - Solvent	C ₃ H ₄ O ₃
	Diethyl Carbonate - Solvent	C ₈ H ₁₀ O ₃
	Lithium Hexafluorophosphate - Salt	LiPF ₆

The overall reaction is: $\text{Li}_x\text{C} + \text{Li}_{1-x}\text{CoO}_2 \rightleftharpoons \text{C} + \text{LiCoO}_2$



DISPOSAL

All Panasonic Lithium Ion batteries are classified by the federal government as non-hazardous waste and are safe for disposal in the normal municipal waste stream. These batteries, however, do contain recyclable materials and are accepted for recycling by the Rechargeable Battery Recycling Corporation's (RBRC) Battery Recycling Program. Please call 1-800-8-BATTERY for information on recycling your used Lithium Ion battery or go to the RBRC website at www.rbrc.org for additional information.

TRANSPORTATION

All Panasonic lithium (primary and rechargeable) batteries are not subject to the requirements of the Department of Transportation (DOT) Subchapter C, Hazardous Materials Regulations because each of our batteries meet the exceptions under 173.185 (b). These regulations will remain in effect until October 1, 2005 when the new regulations are expected to become effective.

All Panasonic lithium batteries are exempt from the DOT Hazardous Materials Subchapter as long as they are separated to prevent short circuits and packed in strong packing for conditions normally encountered in transportation.

Effective January 1, 2003, all Panasonic lithium batteries are regulated as a Hazardous Material by the International Civil Aviation Organization (ICAO) and the International Air Transport Association (IATA) if you transport more than 24 cells or 12 batteries in a single package. These must be transported in accordance with the requirements of Special Provision "A45".

Effective January 1, 2004, all Panasonic lithium batteries will be regulated as a Hazardous Material by the International Maritime Organization (IMO) if you transport more than 24 cell or 12 batteries in a single package. These will have to be transported in accordance with the requirements of Special Provisions 188 and 230.

If you build any of our lithium cells into a battery pack, you must also assure that they are tested in accordance with the UN Model Regulations, Manual of Test and Criteria, Part III, subsection 38.3. If you plan on transporting any untested prototype battery packs contact your Panasonic Sales Representative for regulatory information.

Notice: The information and recommendations set forth are made in good faith and are believed to be accurate at the date of preparation. Panasonic Industrial Company makes no warranty expressed or implied.

Inspired Energy Battery



Product Safety Data Sheet

PRODUCT NAME: Inspired Energy Rechargeable Battery Pack Model: NF2040A22
TRADE NAME: NF2040 Volts: 10.8
CHEMICAL SYSTEM: Lithium Ion Approximate Weight: 340 g

SECTION I – MANUFACTURER INFORMATION

Inspired Energy, Inc. Telephone: (888) 5-INSPIRE (888-546-7747)
12705 N US Hwy 441
Alachua, FL 32816 Date Prepared: Jan 13th 2003

SECTION II – HAZARDOUS INGREDIENTS

Important Note:
The battery should not be opened or burned. Exposure to the ingredients contained within or their combustion products could be harmful.

Material Safety Data Sheet Attached:
Review cell manufacturer's MSDS

SECTION III – OPERATING PARAMETERS

Maximum Charge Voltage:	12.6 V
Minimum Charge Voltage:	7.5 V
Maximum Charge Current:	3.0 A
Maximum Discharge Current:	3.0 A
Recommended Charging Method:	Use an SMBus charger of level 2 or higher to provide a 3.0 A current limited constant voltage of 12.6 V. The charging cycle shall terminate when the average current falls below 150mA.

The information contained within is provided for your information only. This battery is an article pursuant to 29 CFR 1910.1200 and, as such, is not subject to the OSHA Hazard Communication standard requirement for preparation of a material safety data sheet. The information and recommendations set forth herein are made in good faith and are believed to be accurate as of the date of preparation. However, INSPIRED ENERGY, INC. MAKES NO WARRANTY, EITHER EXPRESSED OR IMPLIED, WITH RESPECT TO THIS INFORMATION AND DISCLAIMS ALL LIABILITY FROM RELIANCE ON IT.

PRODUCT INFORMATION AND DATA SHEET

This product is a manufactured article as described in 29 CFR 1910.1200 and is not subject to OSHA's Hazard Communication Standard requirements for preparation of material safety data sheets (MSDS).

SANYO Batteries
SANYO Energy (USA) Corp.
2055 Sanyo Ave.
San Diego, CA 92154
Telephone No.: (619) 661-4888
www.sanyobatteries.com

Manufacturer's Name
SANYO Electric Co., Ltd.
Tokonabe-Cho Kasai-City
Hyogo, 675-2332, Japan
Telephone No.: 0790-43-2043

In case of emergency contact:
CHEMTREC at (800) 424-9300

Section I – Product Information

Product: Lithium Ion Battery

Designated for Recharge? Yes No

Chemical System: Lithium ion

Model: Cylindrical and Prismatic Type Cells

Section II – Composition / Information on Ingredients

The ingredients are contained in a hermetically sealed case, designed to withstand temperatures and pressures encountered during normal use. As a result, during normal use, hazardous materials are fully contained inside the battery. The battery should not be opened or exposed to heat because exposure to the following ingredients contained within could be harmful under some circumstances. The following information is provided for the user's information only.

Chemical Name	CAS No.	PEL	TLV
Lithium Cobaltate (LiCoO ₂)	12190-79-3	None Established	None Established
Graphite (C)	7782-42-5	2.5 mg/m ³ (as dust)	2.5 mg/m ³ (as dust)
Organic Solvent		None Established	None Established
Lithium Salt		None Established	None Established
Polyvinylidene difluoride (PVdF)	24937-79-9	None Established	None Established

Weight of lithium per cell: 0g. There is no metallic lithium in the lithium ion battery.

Section III – Physical Data

Specific Gravity: (H₂O=1): LiCoO₂: 4.95
Graphite: 2.09~2.2

Melting Point: (°C): LiCoO₂ about 1130 C

Appearance and Odor:

LiCoO₂ is a black, odorless powder.

C is a black, odorless powder.

Organic solvent is a colorless or light yellow liquid.

Lithium salt is a white, crystalline and odorless powder.

Section IV – Fire and Explosion Hazard Data

Extinguishing Media: Water

Flammable Limits: Not available

Section V – Health Hazard Data

Routes of Entry:

Inhalation - Yes

Skin - Yes

Ingestion - Yes

Health Hazards (Acute and Chronic):

These chemicals are contained in a sealed can. Risk of exposure occurs only if the battery is mechanically or electrically abused. The most likely risk is an acute exposure when the gas release vent works. Organic solvent has slight toxicity and can irritate skin and eyes. Lithium salt is irritating to skin, eyes and mucous membranes and should be avoided.

Carcinogenicity: NTP: None

IARC Monograph: None

OSHA Regulated: None

Medical Conditions Generally Aggravated by Exposure: An acute exposure will not generally aggravate any medical condition.

Emergency and First Aid Procedures: In case of skin contact with contents of battery, flush immediately with water. For eye contact, flush with copious amounts of water for 15 minutes. Do not inhale leaked material. If irritation persists, get medical help.

Section VI – Reactivity Data

Stability: Stable

Conditions to Avoid: Do not heat, disassemble or overcharge.

Hazardous Decomposition or By-products: N/A

Hazardous polymerization will not occur.

Section VII – Safe Handling and Use

Steps to be Taken in Case Material is Released or Spilled: The preferred response is to leave the area and allow the batteries to cool and the vapors to dissipate. Avoid skin and eye contact or inhalation of vapors. Remove spilled liquid with absorbent and incinerate.

Waste Disposal Method: Open cells should be disposed of in accordance with local regulations

Precautions to be Taken in Handling and Storing: Avoid mechanical or electrical abuse. Batteries may explode or cause burns, if disassembled, crushed or exposed to fire or high temperatures. Do not short or install with incorrect polarity.

Section VIII Control Measures

Respiratory Protection (Specify Type): Not necessary under conditions of normal use.

Ventilation: Not necessary under conditions of normal use.

Protective Gloves: Not necessary under conditions of normal use.

Eye Protection: Not necessary under conditions of normal use.

Other Protective Clothing or Equipment: Not necessary under conditions of normal use.

Date of Last Revision:
March 2006

Page 2 of 3

Section IX – Recycling and Disposal

SANYO encourages battery recycling. Our lithium ion batteries are recyclable through the Rechargeable Battery Recycling Corporation's (RBRC) *Charge Up to Recycle! Program*. For information call 1-800-8-BATTERY or see their website at www.rbrc.org. Lithium ion batteries must be handled in accordance with all applicable state and federal laws and regulations.



DO NOT INCINERATE or subject battery cells to temperatures in excess of 212 F. Such treatment can vaporize the liquid electrolyte causing cell rupture. Incineration may result in cadmium emissions.

Section X – Transportation

Sanyo lithium ion cells and batteries are not subject to the requirements of the U.S. hazardous materials regulations pursuant to 49 CFR 173.185(b), IATA Dangerous Goods Regulations pursuant to Special Provision A45, and IMDG Code pursuant to Special Provision 188. Each Sanyo cell or battery has been tested under provisions of the UN Manual of Tests and Criteria, Part III, Sub-section 38.3. **If Sanyo lithium ion cells are used to construct battery packs, the assembler of that pack is responsible to ensure the battery has been tested in accordance with the requirements contained in the UN Manual of Tests and Criteria and shipped in accordance with applicable regulations.**

Batteries must be packaged and offered for transportation in a manner that prevents the dangerous evolution of heat (for example, by the effective insulation of exposed terminals) and protects against short circuits.

The information and recommendations set forth are made in good faith and believed to be accurate as of the date of preparation. SANYO ENERGY CORP. makes no warranty, expressed or implied, with respect to this information and disclaims all liabilities from reliance on it.

Environmental Requirements

Refer to the Specifications section of this document.

Electrical Requirements

The FieldFox allows you to use either the lithium-ion battery or the AC/DC adapter - both are included.

Electrostatic Discharge (ESD) Precautions

The FieldFox was constructed in an ESD protected environment. This is because most of the semiconductor devices used in this instrument are susceptible to damage by static discharge.

Static charges are generated in numerous ways, such as simple contact, separation of materials, and normal motions of persons working with the FieldFox. To prevent instrument damage, practice industry accepted techniques for handling static sensitive devices when using the FieldFox.

Very often, coaxial cables and antennas also build up a static charge, which, if allowed to discharge by connecting to the FieldFox, may damage the instrument input circuitry. To avoid such damage, it is recommended to dissipate any static charges by temporarily attaching a short to the cable or antenna prior to attaching to the instrument.

FieldFox Markings



The CE mark shows that the product complies with all relevant European legal Directives (if accompanied by a year, it signifies when the design was proven).



The CSA mark is a registered trademark of CSA International.



The C-Tick mark is a registered trademark of the Australian Spectrum Management Agency.



This is a marking to indicate product compliance with the Canadian Interference-Causing Equipment Standard (ICES-001).



This symbol is an Industrial Scientific and Medical Group 1 Class A product (CISPR 11, Clause 4)



The standby symbol is used to mark a position of the instrument power line switch.



This symbol indicates separate collection for electrical and electronic equipment, mandated under EU law as of August 13, 2005. All electric and electronic equipment are required to be separated from normal waste for disposal (Reference WEEE Directive, 2002/96/EC).



Indicates the time period which no hazardous or toxic substance elements are expected to leak or deteriorate during normal use. Forty years is the expected useful life of the product.



CAUTION, risk of danger, refer to safety information in manual.



Dispose of properly



Hot surface - connectors get hot during extended operation, so care must be taken when making connections and disconnections.

Battery Markings



The CE mark shows that the product complies with all relevant European legal Directives (if accompanied by a year, it signifies when the design was proven).



The battery parts can be recycled. Consult local or country regulations.



Dispose of properly



Recycle the old battery properly. Consult local or country regulations related to disposal.



Keep battery away from excessive heat. Do not dispose of by burning.



UL recognized in Canada and the United States.

Packaging Markings



This symbol on all primary and secondary packaging indicates compliance to China standard GB 18455–2001.

AC/DC Adapter Markings



The UL Marks are registered certification marks of Underwriters Laboratories Inc. (UL). It means that UL has tested and evaluated representative samples of that product and determined that it meets UL's safety requirements. When accompanied by a 'C' and 'US', it indicates compliance to both Canadian and US requirements.













NOM Mark (Normality of Mexico) indicates that the product was tested by an accredited laboratory in Mexico and meets Mexico's safety requirements.



Importer Name

Japan's safety and EMC compliance mark.

	China's safety and EMC compliance mark.
	Taiwan's safety and EMC compliance mark.
	Singapore's safety mark.
	Korea's safety and EMC mark.
	GOST, Russia's safety and EMC mark.
	AC (Alternating Current).
	Direct current (DC) equipment
	CAUTION, risk of danger, refer to safety information in manual.
	DC connector polarity
	Dispose of properly

Certification and Compliance Statements

Certification

Agilent Technologies, Inc. certifies that this product met its published specifications at the time of shipment from the factory. Agilent Technologies, Inc. further certifies that its calibration measurements are traceable to the United States National Institute of Standards and Technology, to the extent allowed by the Institute's calibration facility, and to the calibration facilities of other International Standards Organization members.

Manufacturer's Declaration

This product has been designed and tested in accordance with accepted industry standards, and has been supplied in a safe condition. The documentation contains information and warnings that must be followed by the user to ensure safe operation and to maintain the product in a safe condition.

Declaration of Conformity

Should the Declaration of Conformity be required, visit: <http://regulations.corporate.agilent.com/DoC/search.htm>. For more information contact an Agilent Sales Representative, or the closest Agilent Sales Office. See [Contacting Agilent](#).

Compliance with German Noise Requirements

This is to declare that this instrument is in conformance with the German Regulation on Noise Declaration for Machines (Laermangabe nach der Maschinenlaermrrerordnung –3. GSGV Deutschland).

Acoustic Noise Emission	Geraeuschemission
LpA <70 dB	LpA <70 dB
Operator position	am Arbeitsplatz
Normal position	normaler Betrieb
per ISO 7779	nach DIN 45635 t.19

Compliance with Canadian EMC Requirements

This ISM device complies with Canadian ICES–001.
Cet appareil ISM est conforme a la norme NMB du Canada.

Disposal of Batteries



Do not throw batteries away – collect as small chemical waste.

Appendix A: Connector Care Review

Proper connector care and connection techniques are critical for accurate and repeatable measurements. The following table contains for tips on connector care.

Prior to making connections to your analyzer, carefully review the information about inspecting, cleaning, and gauging connectors. For course numbers about additional connector care instruction, contact Agilent Technologies. Refer to:

Handling and Storage

Do

- Keep connectors clean
- Extend sleeve or connector nut
- Use plastic end-caps during storage

Do Not

- Touch mating-plane surfaces
- Set connectors contact-end down
- Store connectors or adapters loose

Visual Inspection

Do

- Inspect all connectors carefully
- Look for metal particles, scratches, and dents

Do Not

- Use a damaged connector - ever

Connector Cleaning

Do

- Try compressed air first
- Use isopropyl alcohol ^a
- Clean connector threads

Do Not

- Use any abrasives
- Get liquid into plastic support beads

Gauging Connectors

Do

- Clean and zero the gage before use
- Use the correct gage type
- Use correct end of calibration block
- Gage all connectors before first use

Do Not

- Use an out-of-specification connector

Making Connections

Do

- Align connectors carefully
- Make preliminary connection contact lightly
- Turn only the connector nut
- Use a torque wrench for final connection

Do Not

- Apply bending force to connection
- Over tighten preliminary connection
- Twist or screw any connection
- Tighten past torque wrench “break” point

^aCleaning connectors with alcohol shall only be done with the DC power cord removed, in a well-ventilated area, and with the power to the FieldFox turned OFF. Allow all residual alcohol moisture to evaporate, and the fumes to dissipate prior to energizing the instrument.

Appendix B : Specifications/Data Sheet

To ensure the highest accuracy and consistency, the N9923A Specifications are stored ONLY at : <http://cp.literature.agilent.com/litweb/pdf/5990-5363EN.pdf>

Index

1

- 1-port cable loss measurements
 - CAT mode, 40
- 1-port cable trimming
 - measurements, VVM mode, 73

2

- 2-port insertion loss measurements
 - CAT mode, 41
- 2-port transmission measurements,
 - VVM mode, 74

A

- AC/DC adapter
 - markings, 132
 - power requirements, 10
 - using, 109
- accessories, 8
- Agilent, contacting, 2
- Alias Faults, 49
- all about limit lines, 84
- all about markers, 76
- all about trace math, 86
- alternate sweep, 48
- appendix A, 113
- appendix B, 135
- averaging, 37
- Averaging
 - NA mode, 26
 - VVM, 72
- avoid overpowering, 13

B

- bandpass mode, 44, 45
- battery
 - care, 111
 - charge status, viewing, 107
 - charging, 12
 - external, 110
 - internal, 109
 - disposal, 112
 - gauge, 108
 - installing, 11
 - LED, 110
 - markings, 132
 - maximizing life, 12, 112
 - protective functions, 124
 - reconditioning
 - external, 111
 - internal, 111
 - safe handling, 126

- service diagnostics, 107
- viewing charge status, 11
- Battery Saver, 100
- bridge cancellation measurements,
 - VVM mode, 74
- brightness, display, 97

C

- cable and antenna test. See CAT
- Cable Editing
 - DTF, 45
- cable loss measurements, 40
- Cal On ?, 59
- Calculated DTF values, 49
- calibration
 - Cal On ?, 59
 - CAT and NA modes, 51
 - verifying integrity, 60
- Calibration Type, 57
- CalReady, 52
- care of the battery, 111
- CAT mode
 - 1-port cable loss measurements, 40
 - 2-port insertion loss measurements, 41
 - calibration, 51
 - DTF measurements, 42
 - return loss measurements, 39
 - settings, 34
- CD, included, 8
- certification statements, 133
- charge status, viewing, 107
- charging the battery
 - externally, 110
 - internally, 109
- Clean Screen, 15
- colors, display, 97
- compliance statements, 133
- connector care review, 135
- considerations, safety, 120
- contacting Agilent, 2
- control, temperature, 12
- Coupled Markers, 78
- cursor, moving, 93

D

- data analysis features, 76
- Date and Time Setting, 103
- date/time setting, 103
- declaration of conformity, 133
- delta marker, 78
- display
 - brightness, 97

- clean, 15
- colors, 97
- front panel, 17
- preferences, 99, 100
- settings, 97
- Display Resolution
 - VVM, 71
- disposal of battery, 112
- dissipate static charge, 13
- distance to fault. See DTF
- distance, start and stop, 43
- DTF
 - measurements, 42
- DTF Settings Page, 49
- Dynamic Range, 31

E

- Electrical Delay, 25
- Erase User Data, 105
- error
 - max, 108, 109, 111
 - red flashing LED, external
 - battery charger, 110
 - systematic, 51
- ESD, 131
- external frequency reference, 103
- external zeroing, 63

F

- features
 - overview, 7
- features, data analysis, 76
- file management, 88
- files
 - managing, 91
 - prefixes, 93
 - printing, 94
 - saving and recalling, 88
- folders, 92
- Format, 23
- frequency
 - external reference, 103
 - range, setting, 35
- Frequency Range
 - CAT mode, 35
 - NA mode, 24
- front panel, 15

G

- gauge, battery, 108
- getting started information, 10
- GPS, 101
- group delay, 24

H

- hardkey/softkey menu, 113
- high-temperature protection, 12
- hold, 95
- how to
 - add or edit a title, 98
 - change
 - units to feet, 44
 - create
 - delta marker, 78
 - limit lines, 85
 - markers, 76
 - determine if a battery needs reconditioning, 111
 - display "live" and memory traces, 86
 - edit keywords, 93
 - edit, enable and disable the current prefix, 93
 - enable the marker table, 78
 - enter
 - numeric values, 18
 - install options, 100
 - make
 - 1-port cable loss measurement, 40
 - 1-port cable trimming measurement, 73
 - 2-port insertion loss measurement, 41
 - 2-Port transmission measurement, 74
 - manage files, 91
 - manage folders, 92
 - measure return loss, 39
 - monitor the internal FieldFox temperature, 12
 - move
 - cursor, 89, 94
 - marker, 76
 - reference marker, 78
 - name files, 88
 - perform
 - external battery reconditioning, 111
 - internal reconditioning, 111
 - normalization, 56
 - O,S, L cal, 55
 - QuickCal, 53
 - single sweep while in Hold, 96
 - trace math, 87
 - preset, 96
 - recall an *.sta file, 89
 - recondition battery with external battery charger, 111
 - save
 - display settings as preferences, 99, 100
 - file, 88
 - save and recall limits, 86
 - select

- language, 99
- NA formats, 24
- power meter mode, 63
- VVM measurements, 70
- VVM mode, 70
- Windows settings, 48
- zeroing, 73

set

- alternate sweep, 48
- bandpass mode ON, 44, 45
- date and time, 103
- display colors, 97
- frequency range, 35
- full screen mode, 98
- interference rejection, 39
- limit options, 85
- output power, 29, 38
- peak criteria, 83
- resolution, 28, 38
- scale, 36
- start and stop distance, 43
- start and stop frequency with alternate sweep, 48
- sweep time, 38
- sweep type, 28, 37, 72
- trace averaging, 37

use

- external reference, 103
- marker search functions, 80

view and change Quick Settings, 23, 35

view the installed options, 100

I

- IF Bandwidth, 27
 - VVM, 71
- initial use, preparing for, 10
- input voltages and power, maximum, 13
- insertion loss measurements, 41
- installing
 - battery, 11
- interference rejection, 39
- Interference Rejection
 - CAT mode, 39
 - NA mode, 29
- Interpolation, 59

K

keywords, 92

L

- LAN Settings, 104
- language, settings, 99
- latest information, where to find, 2
- LED
 - battery, 110
 - on/off settings, 12, 15
- Licensing, 100

- limit lines
 - saving and recalling, 86
 - setting, 85
- lithium-ion battery
 - installing, 11

M

- managing
 - files, 91
 - folders, 92
- manuals, 8
- markers
 - creating, 76
 - delta, 77
 - moving, 76
 - noise, 83
 - search function, 79
 - table, 78
 - trace, 79
- markings
 - AC/DC adapter, 132
 - battery, 132
 - FieldFox, 131
 - packaging, 132
- math
 - operations, 87
- maximizing battery life, 112
- maximum input voltages and power, 13
- measurements
 - 1-port cable loss, CAT mode, 40
 - 1-port cable trimming, VVM mode, 73
 - 2-port insertion loss, CAT mode, 41
 - 2-port transmission, VVM mode, 74
 - bridge cancellation, VVM mode, 74
 - distance to fault (DTF)
 - CAT mode, 42
 - return loss, CAT mode, 39
 - selection, 34
- menu, softkeys/hardkeys, 113
- menus, 113
- mode
 - NA, 19
 - power meter, 62
 - temperature control, 12
 - VVM, 68
- moving the cursor, 93
- multipliers, 18
- Multi-Trace Configurations, 21

N

- NA mode
 - calibration, 51
 - settings, 21
- network analyzer, 19
- normalization, 56

numeric values, 18

O

O, S, L cal, 55
on/off settings, 12
options
 and features, 7
 installing, 100
 viewing, 100
output power, 38
Output Power
 CAT mode, 38
 NA mode, 29
 VVM Mode, 71
overpowering, avoid, 13
overview, 7

P

packaging markings, 132
panel
 front, 15
 side, 16
peak
 criteria, 83
 excursion, 83
 threshold, 83
Phase Offset, 26
Port Extensions, 30
power meter mode, 62
power requirements for the AC/DC
 adapter, 10
power sensor input, 13
Power Sensors, 62
power, maximum, 13
prefixes for file names, 93
preparing for initial use, 10
preset settings, 96
printing, 94
protection, high temperature, 12
protective functions of the battery,
 124

Q

Quick Settings, 23, 35
 CAT mode, 35
 NA mode, 23
QuickCal, 53

R

recalling files, 88, 89
Receiver Measurements, 21

reconditioning the battery
 externally, 111
 internally, 111
reference marker, 78
reference, external frequency, 103
Relative and Offset Power
 Measurements, 65
Resolution
 CAT mode, 37
 NA mode, 28
Response Cals, 56
return loss
 measurements, CAT mode, 39
reviewconnector care, 135
run/hold, 95

S

S11 measurements, NA mode, 21
safety considerations, 120
Save Preferences, 99
saving files, 88
Scale Settings
 CAT mode, 36
 NA mode, 25
scale, setting, 36
Screen cleaning, 15
screen, front panel, 17
service
 diagnostics, 107
service guide, free download, 9
settings
 display, 97
 language, 99
 on/off, 12
 preset, 96
 run/hold, 95
 system, 95
 system configuration, 100
 VVM mode, 70
 windows, 48
side panel, 16
Smoothing, 27
softkey/hardkey menu, 113
S-parameters, 20
Specifications/Data Sheet, 136
stand-by mode, 12
start and stop distance, 43
static charge, dissipate, 13
sweep
 alternate, 48
 time, 38
 type, 28, 37, 72
Sweep Time
 CAT mode, 38

NA mode, 28
system configuration settings, 100
System Impedance (Z0), 29
system settings, 95

T

temperature control mode, 12
Time Zone, 103
time/date setting, 103
title, editing, 98
trace averaging, setting, 37
trace math, 86
Trace Width, 98

U

units, changing, 44

V

values
 multipliers, 18
 numeric, 18
vector voltmeter, 68
Velocity Factor, 31
verifying integrity of
 calibration, 60
 jumper cables, 60
viewing
 charge status, battery, 107
 installed options, 99, 100
Volume Control, 96
VVM Calibration, 70
VVM mode
 1-port cable trimming
 measurements, 73
 2-port transmission
 measurements, 74
 bridge cancellation
 measurements, 74
 settings, 70

W

where to find the latest information,
 2
windows settings, 48

Z

zeroing, external, 63